

**P20S**

## Batería de 20 V Litio 2.0 Ah



**605210**

**TFBLI20011**

**2.0Ah**

Indicador Led de carga

Esta batería es compatible con +120 herramientas inalámbricas Total



**INDUSTRIAL**

**P20S**

## Batería de 20 V Lithium-Ion 4.0 Ah



**605211**

**TFBLI2002**

**4.0Ah**

Indicador Led de carga

Esta batería es compatible con +120 herramientas inalámbricas Total



**INDUSTRIAL**

**P20S**

## Cargador inteligente de 20 V



**605212**

**UTFCLI2001**

Rápido para Baterías Lithium-Ion 2.0 Ah Carga Total en 1 hora

4.0 Ah. Carga Total en 2 horas

Voltaje 110-240 V / 50-60 Hz



**INDUSTRIAL**

### Bateria 12V

**605203** **TBLI12152**

Voltaje 12V (1.5AH)  
Para Utdli228120



### Cargador De Taladro

**216740** **UTCLI12071**

Voltaje 12V



### Batería Litio Ion 20v - 2.0Ah

**605210** **TFBLI20011**

Litio 2.0 Ah  
Indicador Led De Carga



## Bateria Litio De 12V

**605202** **TBLI12151**

Voltaje 12V (1.5AH)  
Para Utdli1211



## Cargador Usb-A Para Celulares Y Otros Equipos

**216746** **TUCLI2001**

No incluye bateria  
Ni cargador  
Potencia de salida 5v/1A 5v



## Taladro Inalambrico Percutor 20 V De 3/8" 45 Nm 0-400/0

**605208** **UTDLI20012**

Trae 2 Baterias  
Luz De Trabajo Integrada  
Indicador Led De Bateria  
Trae 1 Broca Para Destornillador  
Trae 3 Brocas Para Mamposteria  
Cargador Inteligente 110-120 V ~ 50/60 Hz



## Atornillador de impacto 20V 1/4" industrial

**P20S**

**605206 UTIRLI2002**

**MOTOR  
SIN ESCOBILLAS**

Atornillador impacto dado hexagonal 1/4»

Brushless sin escobillas

Torque 200NM incluye 1 cargador

2 baterías litio y maletín

Carga total en 1 hora. 110V-240V~50/60Hz



**2.0Ah**



**INDUSTRIAL**

## Atornillador impacto dado cuadrado 1/2» litio 20V

**P20S**

**605205 UTIWLI2001**

**MOTOR  
SIN ESCOBILLAS**

Atornillador impacto dado cuadrado 1/2» litio 20V

Brushless sin escobillas

Torque 300NM incluye 1 cargador

2 baterías litio y maletín

Carga total en 1 hora. 110V-240V~50/60Hz



**2.0Ah**



**INDUSTRIAL**

## Taladro rotomartillo inalámbrico SDS de impacto 20V

**P20S**

**605229 TRHLI1601**

Con función impacto 1.5J

NO incluye cargador ni baterías

Tasa de impacto 0-5100bpm

Máxima capacidad de perforación 16mm

Luz integrada



**2.0Ah**



**INDUSTRIAL**

## Taladro Percutor 3/8"

**605209** **UTIDLI2002**

Batería de ion de lithion  
Mandril 3/8"  
Voltaje 20 voltios  
Velocidad 0-400 / 0-1500 / min  
Máximo de torque 45 nm  
Capacidad de metal 10 mm (3/8")  
capacidad para madera: 25mm  
Concreto capacidad 3/16-3/8"  
Torque 18+ 1 + 1



## Taladro Inalambrico De 1/2" 20V Funcion De Impacto

**605204** **UTIDLI20031**

Amperaje 2.0Ah  
Voltaje 20V  
Torque máx 45NM  
Velocidad 0-450/0-1900/min  
Incluye 2 baterías 20V y cargador



## Taladro Inalambrico 12V De 3/8" 20Nm 0-600/Min Litio 12V

**605239** **UTDLI1211**

Control de torque 15+1  
Máximo torque 20NM  
Tipo de batería Litio 1.5 Ah  
Tiempo de carga 2 hr  
Mandril 3/8" sin llave  
( funciona con brocas desde 0.8 mm a 10mm)  
Capacidad Capacidad de Perforación: 0.8 - 10mm

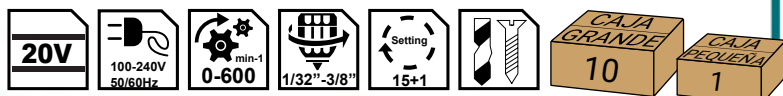

## Taladro 12V Batería De Litio 0-600Rpm

**605200** **UTDLI12415**

20nm mandril de 1/32" o 3/8" sin llave  
 Luz integrada de trabajo  
 Control de torque 15+1  
 Incluye (1) batería de 1.5 ah  
 Cargador 110v-120v~60hz  
 Una punta cr-v 65mm



## Taladro 12V S12 De Baterías Litio 0-400/0-1500Rpm

**605675** **UTDLI12352**

Mandril 3/8" sin llave  
 Luz integrada de trabajo  
 Control de torque 15+1  
 110v-120v~60hz  
 Incluye (2) baterías de 1.5 ah  
 Cargador, una broca de 65mm y bolso



## Taladro De Impacto 12V 0-400/0-1500/Min

**605201** **UTIDLI1232**

Impacto 22500/min 20nm  
 Mandril de 1/32" o 3/8" sin llave  
 Luz integrada de trabajo  
 Control de torque 18+1+1  
 Batería de 1.5 ah  
 Cargador 110v-120v~60hz  
 (1) punta cr-v 65mm  
 (3) brocas para concreto



## Taladro Inalambrico 20V 3/8"

**605207** UTDLI20011

Voltaje: 20v  
 Velocidad sin carga 0-400/0-1500/min  
 Máximo torque 45nm  
 Mandril 1/32"~3/8"  
 Control de torque 15+1  
 Velocidades 2  
 20v batería de litio de 1.5ah  
 Cargador de carga rápida 110-120v~60hz



**P20S**  
**1.5Ah**



## Taladro Inalambrico Percutor 20 V De 3/8"

**605673** UTIDLI20012

Trae 2 Baterias 1 Cargador Inteligente  
 110-120 V ~ 50/60 Hz  
 Luz De Trabajo Integrada  
 Indicador Led De Bateria  
 Trae 1 Broca Para Destornillador  
 Trae 3 Brocas Para Mamposteria



**P20S**  
**2.0Ah**



## Taladro Inalambrico 12v 3/8"

**605670** UTDLI1222

Voltaje 12v  
 Velocidad sin carga 0-350 / 0-1350 / min  
 Par máximo 25nm  
 Capacidad del portabrocas 0.8-10 mm  
 Configuraciones de par 15 + 1  
 12v litio-ion 1.5ah baeries engranaje  
 Mecánico de 2 velocidades



Impact function



## Kit Combo Inalámbrico De Litio Drill E Impacto 12v

**216739** **UTKLI1201**

Bolso Maletín De Herramientas Incluye:

- (1) Llave De Impacto De 1/4"
- (1) Taladro Inalámbrico 3/8"
- (2) Baterías De Litio 1.5Ah
- (1) Cargador Rápido 110V~50/60Hz
- Taladro Inalámbrico: Voltaje: 12V
- Velocidad Sin Carga: 0-350/0-1350/Min
- Control De Torque: 15+1
- Mandril: 3/8" Sin Llave



## Taladro 12V Nueva Generación S12 De Baterías Litio

**605675** **UTDLI12325**

Incluye: (2) baterías de 1.5 ah, cargador, una broca de 65 mm y bolso

- Tipo de batería: litio 12v
- Rpm: 0-400/0-1500rpm
- Mandril: 3/8" sin llave
- Control de torque: 15+1
- Torque/fuerza: 20nm
- Luz integrada de trabajo



## Rotomartillo Sds Plus 5/8 Industrial

**605230** **TRHLI2201**

- Impactos por minuto 0-4700 ipm
- Capacidad de perforación en hormigón 22 mm
- Amperaje batería 2.0-4.0 ah
- Voltaje batería 20 v
- velocidad sin carga 0-1350 rpm

**P20S**  
**BLMOTOR**





## Pistola rociadora 20V inalámbrica

**P20S**

**605236 TSGLI2001**

No necesita compresor  
 Presión 0.1 -0.2bar  
 Flujo de 600ml/min  
 Viscosidad máxima de la pintura 40DNI-s  
 Trae una aguja de mantenimiento y vaso para medir  
 No incluye cargador ni baterías

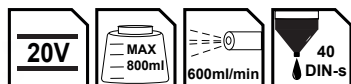

**2.0Ah**



## Caladora 20V / sin batería

**P20S**

**605231 TJSLI8501**

Sierra caladora inalámbrica 20V 2600rpm  
 Capacidad de corte 8mm metal  
 80mm madera  
 No incluye cargador ni baterías



**2.0Ah**



## Tinflador De Llantas Portatil Litio 20V

**P20S**

**605223 TACLI2001**

Luz de LED integrada  
 Manómetro incorporado  
 Presión máxima: 150 PSI/10 Bar  
 Incluye 1 adaptador para inflar pelotas  
 Incluye 1 adaptador para inflar neumáticos



**2.0Ah**



## Compresor de aire automático batería de litio 20 V

605224

TACLI2002

**P20S**

No incluye Batería ni Cargador  
 Presión Max. 160 PSI (11 Bar)  
 Trae 3 Luces LED. Pantalla Digital  
 Parada automática a la Presión Especificada  
 Alimentado por vehículo o por batería  
 Trae cable de 3 m. para encender cigarrillos  
 Trae 1 adaptador de bola  
 Trae 1 adaptador de válvula para neumáticos



**2.0Ah**



## Radio a batería 20v am/fm con bluetooth 4.0

605225

TJRLI2001

**P20S**

Frecuencia AM: 522-1620KHz  
 Frecuencia FM: 87.5-108MHz  
 Jack auxiliar: 3.5 mm  
 Salida de altavoz: 3 W  
 Bluetooth 4.0  
 Puerto de Carga USB  
 No incluye Batería y cargador

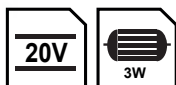

**2.0Ah**



## Motosierra 20V 720W BL

**P20S**

605221

TGSLI2001

No incluye Batería ni Cargador  
 Motor sin escobillas  
 Max. Potencia 720 W  
 Velocidad de Cadena 7.7 m/s  
 Longitud de la Barra Cortadora 12»



**4.0Ah**



**INDUSTRIAL**

## Destornillador / Atornillador Inalambrico 4v

**605200** TSDLI0403

Voltaje 4V  
 Cuadrante 1/4" (6.35mm)  
 Velocidad sin carga 260/min  
 Max. torque 5N.m  
 Luz de trabajo integrada



## Flexible Inalámbrica 4 1/2" 20V. 8500 Rpm

**605228** UTAGLI1152

Voltaje 20V  
 Motor sin escobillas  
 Velocidad sin carga 9000/min  
 Diámetro de disco 4-1/2"  
 Eje enroscado 5/8" - 11UNC

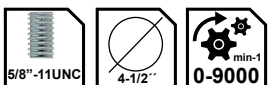

Battery and charger **NOT** included

## Sierra Circular Inalambrica De Litio 4.0Ah

**216742** TSLI1401

Velocidad sin carga 3600/min  
 Diametro de hoja 140mm  
 Capacidad de corte  
 45 grado 1 - 1/8" [28.5mm]  
 90 grado 1 - 9/16" [39mm]



Battery and charger **NOT** included

## Sierra Circular Inalambrica De Bateria De Litio 20V 4.0 Ah

**216743** **TSLI1651**

Voltaje 20V  
 Velocidad 4600rpm  
 Diámetro de disco 165mm - 6 1/2"  
 Capacidad de corte 45° grados:38mm / 90°  
 Profundidad de Corte Ajustable  
 Bisel de Corte Ajustable  
 Incluye Disco de Corte 165mm



**P20S**  
**BLMOTOR**



## Taladro Inalambrico Percutor 20 V De 3/8"

**605673** **UTIDLI20012**

Trae 2 Baterias 1 Cargador Inteligente  
 110-120 V ~ 50/60 Hz  
 Luz De Trabajo Integrada  
 Indicador Led De Bateria  
 Trae 1 Broca Para Destornillador  
 Trae 3 Brocas Para Mamposteria



**P20S**  
**2.0Ah**



## Aspiradora De Limpieza Inalambrica 20V

**216744** **TVLI2005E**

Fuerza de vacio => 8 kpa  
 Capacidad 20 L  
 Diametro de manguera de succion 32 mm  
 Longitud de manguera 1.5 m  
 Tanque de acero inoxidable  
 No incluye cargador ni baterias

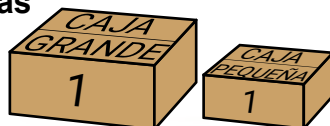

## Flexible Inalámbrica 4 1/2" 20V. 8500 Rpm

**216741** **UTAGLI11522**

Voltaje 20V  
 Motor sin escobillas  
 Velocidad sin carga 9000/min  
 Diámetro de disco 4-1/2"  
 Eje enroscado 5/8" - 11UNC  
 Con +2 pilas a Ah +cargador



## Guadaña Inalámbrica 40V De Doble Batería De Litio 20V

**605219** **TSTLI20018**

Dia línea 2.0mm  
 Dia corte 330mm  
 Motor sin escobillas  
 No incluye batería ni cargador  
 Velocidad de 0-5500/min 0-7500/min  
 Voltaje: 40v (requiere usar dos baterías 20v)



## Herramienta Multifunción Oscilante 20V

**605672** **TMLI2001**

Velocidad Variable: 5000-20000 rpm  
 Con 1 raspador flexiblel  
 Con 1 hoja de sierra de corte  
 Con 1 hoja de sierra de segmento  
 Con 1 llave hexagonal  
 Con 1 base de lijado  
 Con 3 hojas de papel de lija  
 No incluye Batería y cargador



Battery  
 and charger  
**NOT** included



## Tijeras De Podar Eléctricas Inalámbrica De Batería Litio 20V

**605671** TSSLI2001

Voltaje 20V  
Motor Sin Escobillas  
Diámetro De Corte 20Mm / 30Mm  
No Incluye Batería Ni Cargador



Battery and charger  
**NOT** included



## Linterna De Iones De Litio 12V

**605676** TWLI1223

Voltaje 12V  
Disipación de potencia LED 1W  
Brillo 100 lúmenes  
Cargador No incluido  
Batería No incluido  
Compatible con 12V 1.5Ah



Lithium-Ion  
**S12**



## Lampara De Trabajo Inalámbrica Litio 20V

**216745** TFLI2002

Led 20W  
No Incluye Cargador Ni Baterías  
1500 Lumen En Alta Y Baja De 750 Lumen



## Destornillador inalámbrico 8V 1/4"

**605227** **UTSDLI0801**

- Batería de 8 v vástago hexagonal de 1/4"
- Velocidad sin peso 220 rpm
- Torque max 6 nm. Ajuste de torque: 15 + 1
- Trae 1 batería interna
- Voltios de carga 110v-120v ~ 50 / 60hz
- Luz de trabajo integrada
- Trae 1 cargador (2 hr)
- Indicador de carga de batería
- Trae 10 brocas de 25 mm cr-v
- Trae 4 brocas hss con vástago hexagonal
- Trae 1 soporte magnético para las brocas

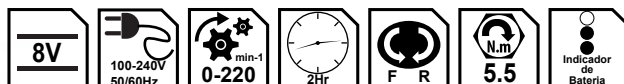

## Taladro percutor 1050W de 5/8"

**605243** **UTG111165**

- Velocidad variable 0-1100rpm/0-3000rpm 110V-120V
- Swich de reversa
- Caja de engranajes en aluminio
- Calidad industrial

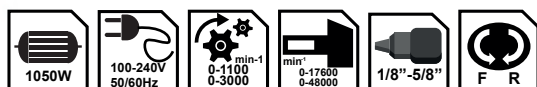

## Taladro eléctrico 3/8" de 500 W

**605244** **UTD2051026**

- Reversible
- Voltaje: 110-120V ~ 60Hz
- Velocidad sin Peso: 0-3300 rpm
- Capacidad de agarre 1/16 »- 3/8"
- Velocidad variable



## Demoledora 2200W Sds Hex 28Mm

**216749** **UTH220502**

Frecuencia 50/60Hz

Incluye Maletín y 2 cinces hex

Mandril SDS HEX

Materiales Carcasa y caja de engranajes de aluminio

Nivel de ruido 105.38dB(A)

Peso (Kg) 30kg

Potencia 2200W



## Aspiradora De Mano Inalambrica P Autos

**P20S**

**605217** **TVLI2001**

Voltaje: 20 v

Usos: domestico

Incluye: trae 1 manguera flexible

1 cepillo para piso y 2 piezas de tubo de plástico

Materiales: tanque de acero inoxidable

Presión de aspirado:  $\geq 7.0$  kpa

Capacidad de polvo: 0.7 l



## Cortadora De Arbustos Bateria Litio 20V

**P20S**

**605220** **THTLI20018**

Diámetro: 330mm

Largo de sierra: 450mm (18")

Distancia entre dientes 18mm

RPM 1400rpm

Voltaje 20V





## Juego De Herramientas De 81 Piezas De Uso Domestico Con Taladro Inalámbrico 12V

**605421** UTHKTHP10812

Usos Domestico

Se vende por Maletin

Voltaje Bateria de Litio 12V, Cargador 110-120V~60Hz

Tiempo de carga Carga bateria en 2 horas depende de uso.



## Lijadora De Palma Electrica

**503073** UTF2231106

Voltaje 110-120V~50/60Hz

Potencia: 240W

Velocidad Sin Carga: 14000/Min

Base: 4 3/8" X4"

Incluye:

(5)Pcs Papel Lija (P120X2Pcs,P80X3Pcs)

Set De Brocha De Carbón



## Lijadora Orbital De 5" (125Mm) Litio De Bateria De 20 V

**605233** TROSLI2001

Diámetro 5"

Voltaje 20V

Incluye (5) pads de lijas

No Incluye Bateria Ni Cargador

Velocidad Max. Sin Peso 10000 Rpm

Observaciones No incluye bateria ni cargador



## Linterna De Mano Aleación De Aluminio Grado De Aviación: 6N01-T6.

**605651** **TCFL186503**

**Brillo:**

**Max 400 lúmenes**

**Medio 150 lúmenes**

**Bajos 50 lúmenes**

**Usar batería de iones de litio 18650**

**Tiempo de ejecución 4h de alta luz**

**Tiempo de ejecución de baja luz 18h**

**Cuatro interruptores resaltado, luz media, luz baja**

**Diámetro/longitud 27,5 mm/158,3 mm**



## Lampara De Trabajo Inalámbrica Litio 20V

**605238** **TWLI2001**

**Voltaje: 20V**

**Lumen: 225 lumen**

**Potencia: Led 3.2W**

**Tipo de batería: Litio**

**Material: Plástico - Metal**



## Medidor De Humedad Digital Con Pantalla Lcd

**605519** **TETWM01**

**Para Madera Y Materiales De Construcción**

**Con Sonda De Acero De 2 Pines**

**Rango De Medición: Madera: 2%-70%**

**Precisión De Humedad:  $\pm 2\%$**

**Temperatura: 0-40°C**

**Precisión De Temperatura:  $\pm 1^\circ\text{C}$**

**Tiempo 1Segundo**



## Mezclador Para Mortero Lithium-Ion De Bateria De 20 V

**605235** **TMXLI2001**

Velocidad sin carga: 0-650 rpm  
 Hilo de la rozca mezcladora: M14  
 No incluye Bateria y cargador  
 Usar Mezclador M14 Codigo Tac331120



## Multimetro Digital

**605650** **TMT46001**

Voltaje DC 200mV / 2V / 20V / 200V / 600V  
 AC Voltaje 200V / 600V  
 Corriente DC 200 $\mu$ A / 2mA / 20mA / 200mA / 10A  
 Corriente AC 200V / 600V  
 Resistencia: 200 $\Omega$  / 2k $\Omega$  / 20k $\Omega$  / 200k $\Omega$  / 2M $\Omega$   
 Ciclo de trabajo: 5-95



## Medidor De Abrazadera Pinza Amperimetrica

**605410** **TMT42002**

Con Retencion De Datos.  
 Corriente Ca: 2A / 20A / 200A /  $\pm$  (2.5% +8).  
 Voltaje De Ca: 0.1 ~ 600V  $\pm$  (1.0% +5).  
 Voltaje Dc: 0.1 ~ 600V  $\pm$  (0.5% +5).  
 Resistencia: 2K $\omega$  / 20K $\omega$   $\pm$  (1.0% +3)



## Medidor De Abrazadera Pinza Amperimetrica

**605411** **TMT46003**

Con Retencion De Datos

Corriente Ca: 6A / 60A / 600A /  $\hat{A}\pm (2.5\% +8)$

Voltaje De Ca: 0.1 ~ 600V  $\hat{A}\pm (0.8\% +5)$

Voltaje Dc: 0.1 ~ 600V  $\hat{A}\pm (0.5\% +3)$

Resistencia: 0 ~ 60K $\hat{\Omega}\pm (0.8\% +3)$



## Medidor De Abrazadera Digital Ac/Dc

**605412** **TMT46004**

Pantalla De 6000 Dígitos

Prueba De Sonda/Rms/Lpf

Verdadero Función De Retroiluminación

Con Función De Luz De Flash

Con Función De Indicación De Batería Baja



## Bateria De 20 V Lithium-Ion 5.0 Ah

**143837** **TFBLI2053**

Voltaje 20V

Serie 20VMax

Indicador Led De Carga

Tipo Herramientas Inalambricas



## Pistola Silicona Inalambrica 20v

**605237 TGGLI2001**

Volumen de pegamento 13-8 gr rpm  
 Tiempo de calentamiento 60 seg  
 Diámetro de las barras de silicona: 11.2m



## Pistola Spray de Aire para Pintar

**605267 UTT3506**

Capacidad de Envase 800 ml  
 Voltaje: 110-120 V ~ 50 / 60Hz  
 Potencia de entrada: 350 W  
 Presión de pulverización: 0.1-0.2 Bar  
 Flujo máximo: 380 ml / min  
 Max. viscosidad: 50 DIN-s  
 Accesorios: 1 vaso medidor de viscosidad  
 1 aguja de limpieza de boquilla



## Detector De Voltaje 12v 1000v

**605516 THT2910003**

Voltaje de CA: 12V ~ 1000V (alta sensibilidad)  
 48 ~ 1000V (baja sensibilidad)  
 Frecuencia: 50 / 60Hz  
 Modo de alarma: alarma de sonido y luz  
 Garantía 1 año



## Destornillador Inalámbrico 1/4" De Litio 4 V

**605226** TSDLI0402

Voltaje: 4V

Velocidad sin carga: 180/min

Vástago hexagonal: 1/4"

Máximo torque: 4NM

Tiempo de carga: 1.5hrs

Luz integrada

Incluye:

1.(10) Puntas magnéticas

2.(1) Sostenedor de puntas



## Generador De Gasolina De 800 Watts 110V 60 Htz

**605278** UTP18001

HP: 2.0 HP

Frecuencia: 50/60Hz

Potencia Nominal: 650W

Potencia Máxima: 800W

Capacidad Tanque: 4 L

Capacidad nominal: 0.65Kw /Max 0.8Kw

Motor: Gasolina de 2.0 HP de Dos Tiempos

Recomendaciones: Usar aceite de 2 tiempos, Mezcla 50:1



## Desmalezadora Inalámbrica De Batería De Litio 20V

**310501** TGTLI20018

Velocidad : 8200 rpm

Longitud de corte: 300mm

Diámetro de tanza: 1.6mm

Largo de tanza: 5m

Sistema de tanza automático

Caño telescópico

Diseño ergonómico

Mango auxiliar con angulo ajustable

Posición de corte ajustable



## Taladro 850W 1/2" percutor

**605241** **UTG109136**

0-2400rpm 110-120v ~ 60hz

1/16" - 1/2"

1 mango auxiliar

1 set de carbones

1 medidor de profundidad

1 llave de ajuste



## Llave de impacto 550 NM

**605245** **UTIW10101**

Voltaje: 110-120V~50/60Hz

Potencia: 1050W

Caja de engranajes en aluminio

Trae 6 dados de impacto sockets (17,18,19,21,23,24mm)

y adaptadores



INDUSTRIAL

## Taladro 1010W 1/2" percutor

**605242** **UTG111136**

Velocidad variable 0-2800rpm 110V-120V

Swich de reversa

Caja de engranajes en aluminio.

Calidad industrial



INDUSTRIAL

## Destornillador inalámbrico 8V 1/4"

**605227** **UTSDLI0801**

- Batería de 8 v vástago hexagonal de 1/4"
- Velocidad sin peso 220 rpm
- Torque max 6 nm. Ajuste de torque: 15 + 1
- Trae 1 batería interna
- Voltios de carga 110v-120v ~ 50 / 60hz
- Luz de trabajo integrada
- Trae 1 cargador (2 hr)
- Indicador de carga de batería
- Trae 10 brocas de 25 mm cr-v
- Trae 4 brocas hss con vástago hexagonal
- Trae 1 soporte magnético para las brocas

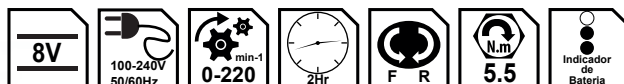

## Taladro percutor 1050W de 5/8"

**605243** **UTG111165**

- Velocidad variable 0-1100rpm/0-3000rpm 110V-120V
- Swich de reversa
- Caja de engranajes en aluminio
- Calidad industrial

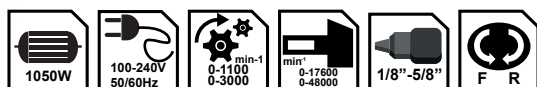

## Taladro eléctrico 3/8" de 500 W

**605244** **UTD2051026**

- Reversible
- Voltaje: 110-120V ~ 60Hz
- Velocidad sin Peso: 0-3300 rpm
- Capacidad de agarre 1/16 »- 3/8"
- Velocidad variable





## Taladro 850W 1/2" percutor

**605241** **UTG109136**

0-2400rpm 110-120v ~ 60hz

1/16" - 1/2"

1 mango auxiliar

1 set de carbones

1 medidor de profundidad

1 llave de ajuste



## Llave de impacto 550 NM

**605245** **UTIW10101**

Voltaje: 110-120V~50/60Hz

Potencia: 1050W

Caja de engranajes en aluminio

Trae 6 dados de impacto sockets (17,18,19,21,23,24mm)

y adaptadores



INDUSTRIAL

## Taladro 1010W 1/2" percutor

**605242** **UTG111136**

Velocidad variable 0-2800rpm 110V-120V

Swich de reversa

Caja de engranajes en aluminio.

Calidad industrial



INDUSTRIAL

## Rotomartillo Sds Plus 800W

**605251** UTH308268-2

Voltaje 110V-120V~60Hz  
 Energía De Impacto 2.5J  
 Velocidad Sin Carga 0-1100/Min  
 Tasa De Impacto 0-4000Bpm  
 Mandril Sds Plus  
 Perforación En Concreto 26Mm  
 Perforación En Acero 13Mm  
 Perforación En Madera 30Mm  
 Incluye (3) Brocas, (2) Cinceles Y Maletín



## Pistola De Silicon Con 8 Barras De Silicona

**605260** UTT301116

Diámetro De Barra 11.2 mm  
 Voltaje: 110-120 V ~ 50 / 60Hz.  
 Potencia De Entrada 30 W (220 W)  
 Capacidad De Pegado 20-30G / Min  
 Tiempo De Pre calentamiento 3-5 Minutos  
 Sistema De Alimentación Mecánica Para  
 Medición Sensible Y Aplicación Rápida



## Pistola De Calor 2000W

**216753** UTB20036

Potencia 2000W  
 Voltaje 110-120V~50/60Hz  
 Temperatura 480°C/560°C  
 Incluye: 3 boquillas y un raspador de metal



## Pulidora Industrial 7" 2000W

**605248** **UTG12018026**

Esmeril angular de 7"  
 Voltaje 110-120v~/60hz  
 Potencia 2000w  
 Velocidad sin carga 8450 /min  
 Diámetro de disco 7"  
 Eje enroscado 5/8 – 11unc  
 Mango auxiliar  
 Escobilla de carbón extra



## Rotomartillo 1050W

**605252** **UTH110286**

Encastre rápido sds plus  
 Solo rotación  
 Rotación por percutor  
 Función martillo, sólo golpe  
 Sistema que reduce las vibraciones  
 Voltaje/frecuencia 220-240v~50-60hz  
 Potencia 1050 watts/vatios  
 Velocidad 900 rpm  
 Impactos 4000/min



## Rotomartillo 1500W SDS

**605253** **UTH1153226**

Velocidad sin carga 850/min  
 Velocidad de impacto (bpm): 4400/min  
 Voltaje: 110-120v~/50/60hz  
 Capacidad de perforado en concreto 32 mm,  
 Acero 13 mm, madera 40 mm  
 Incluye 3 brocas, 2 cinceles y maletín  
 Motor con escobilla



## Pulidora angular 2400W

**605250** UTG1252306

RPM 6400/min  
 Potencia De 2400 W  
 Mandril 5/8 -11UNC  
 Diámetro de disco 7", 9"  
 Voltaje 110-120V~60Hz  
 Velocidad Max. Sin Peso 6300 Rpm  
 Trae 1 Mango Auxiliar De Agarre



## Pulidora Mini Industrial 900w

**605246** UTG10912556

Potencia 900W  
 Voltaje 110-120V~/60Hz  
 Diámetro De Disco 5"  
 Velocidad Sin Carga 12000 Rmp  
 Características Mango ergonomico



## Pulidora Mini Industrial 900w V/ Variable

**605247** UTG109125565

Potencia 900w  
 Mango Auxiliar  
 Diámetro De Disco: 5"  
 Voltaje 110-120v~/60hz  
 Eje Enroscado 5/8 - 11Unc  
 Velocidad sin carga 5000-11000 /min



Variable  
Speed

## Taladro 280W 3/8"

216747

UTD502106

Cable 4M  
 20+1 Ajustes De Par  
 Mandril Sin Llave De 10 Mm  
 Taladro Eléctrico 280W  
 Voltaje 110V-120V ~ 60Hz  
 Potencia De Entrada 280W  
 Velocidad Sin Carga 0-750Rpm  
 Capacidad De Perforación Máxima 3/8"



## Flexible Lijadora De 4-1/2"

602545

UTG10711556

Esmeril Angular De 4-1/2"  
 Voltaje 110V-120V~60Hz 750W. 5/8"  
 Velocidad Sin Carga 12000 /Min  
 Diámetro De Disco 4-1/2"  
 Eje Enroscado 5/8 - 11Unc  
 Mango Auxilia



## Pulidora De Felpa 1400W De 7"

216748

UTP1141806

Potencia 1400W  
 Vel.900-3800Rpm  
 Caja De Engranajes En Alum  
 Diámetro de disco 180 mm (7")  
 Incluye 1 Felpa Y 1 Plato  
 Voltaje 110V-120V~60Hz



## Esmeriladora Angular 5" 1500W

**605668** **UTG11512526**

Voltaje 110-120v ~ 50 / 60hz  
 Potencia de entrada 1500w  
 Velocidad sin carga 11000rpm  
 Diámetro del disco 5"  
 Rosca de husillo 5/8"-11unc  
 Con mango auxiliar de 1pcs  
 Con cepillos de carbono de 1 conjunto  
 Con llave de 1pcs  
 Embalado por caja de colores



Variable  
Speed



## Esmeriladora Angular 7" 2400W

**605665** **UTG1251806**

Potencia 2350W  
 Diámetro De Disco 7", 9"  
 Eje Enroscado 5/8 - 11Unc  
 Voltaje 110-120V~50/60Hzda  
 Velocidad Sin Carga 8500, 6300 /Min



## Sierra circular 1400W

**216751** **UTS1141856**

Voltaje 110-120v~50/60hz  
 Potencia 1400w  
 Velocidad sin carga 4800/min  
 Capacidad de corte 90°=65mm/45°=44mm  
 Diámetro de disco 185mm



## Sierra Ingleteadora 8-1/4" 1400W

**605269** **UTS42142101**

Base de aluminio

Max corte 55x120mm

Incluye 1 disco de corte de 8-1/4 de 24 t

Para madera

110-120v~60hz

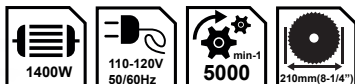

INDUSTRIAL

## Tronzadora De Hierro 2350 W

**605264** **UTS92035526**

Velocidad max. 3800 rpm

Diámetro de hoja de sierra de 355 x 25.4 x 3 mm

Capacidad de corte en tubos redondos 100mm

En acero cuadrado 100x100mm

En acero rectangular 120x100mm

En barra de acero 30mm

Trae 1 pieza de disco de corte de 355mm

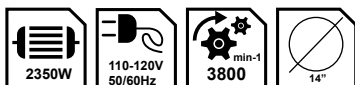

## Máquina De Soldadura Inverter 160A

**605275** **UTW21605**

Ultra liviana

110/220v 50/60hz

Incluye pinza tierra

Pinza electrodo

Cepillo y careta

Electrodo 7018 de 3/16" al 30% de ciclo

Heavy duty solda 7018 1/8" al 60% ciclo trabajo



## Taladro De Banco 350W

**216754** **UTDP133501**

Voltaje 110-120v ~ 60hz.  
 Capacidad máxima de perforación 1/2»  
 Velocidad sin peso 760-3070 rpm  
 Ajustes de velocidad 5 niveles  
 Husillo 50 mm. Diámetro de la columna 46 mm  
 Mesa de trabajo ajustable  
 Tamaño de la mesa 160 x 160 mm  
 Tamaño base 291 x 183 mm  
 Peso neto 19 kgs  
 Altura de la máquina 590 mm



## Flexible Lijadora De 4-1/2"

**216755** **TS9204051**

Voltaje 220-240v ~ 50 / 60hz  
 Potencia de entrada 3000w  
 Sin velocidad de carga 2280 / min  
 Diámetro de la hoja 405 mm \* 25,4 mm \* 3 mm  
 Capacidad de corte tubo de acero 135 \* 6 mm  
 Angulo de hierro 100 \* 10 mm  
 Canal de acero 126 \* 53 mm



## Taladro De 1/2" 680W

**605240** **UTG1061356**

Mandril 13mm  
 RPM 3000 rpm  
 Voltaje 110V-120V~60Hz  
 Velocidad sin carga 0-3000/min  
 Capacidad 2 velocidades en ambos sentidos





## Pulidora Industrial 9" 2200W

**605249** **UTG12223026**

Esmeril angular de 9"»  
 Voltaje: 110-120V~/60Hz  
 Potencia: 2200W  
 Velocidad sin carga: 6600 /min  
 Diámetro de disco: 9"  
 Eje enroscado: 5/8 – 11UNC  
 Mango auxiliar  
 Escobilla de carbón extra



**PORTA PUNTAS DE  
 DESTORNILADOR DE 60 MM**

**605440** **TAC461601**



Material acero + Cr-v  
 peso: 1/4  
 Largo: 60mm



**DISCO PULIR  
 TURBO 4-1/2" (115MM)**

**605301** **TAC2411151**



Diámetro: 115mm (4-1/2")  
 Ancho: 20mm  
 Eje: 22.22mm



**CEPILLO DE ALAMBRE  
 ENROSCADO 3»**

**605438** **UTAC32031**



Con rosca 5/8» 11 UNC  
 Diámetro alambre 0.3 mm  
 (N1-P2-L13-02-02)



## Mandril 1/2" (13Mm) + Llave + Adaptador Sds Plus

**605302** **TAC451301.1**

Capacidad mandril: 1.5-13mm  
 Tamaño conexión: 1/2"-20UNF  
 Incluye un adaptador



## Demoledor Industrial

**605266** **UTH215456**

Voltaje 110-120v~60hz  
 Potencia 1700 w  
 fuerza de impacto 50 joules  
 Peso de demoledor 16 kg  
 Sistema de encastre sds hexagonal  
 Viene estuche con ruedas  
 Capacidad de impacto 1900 gpm(golpes por minutos)

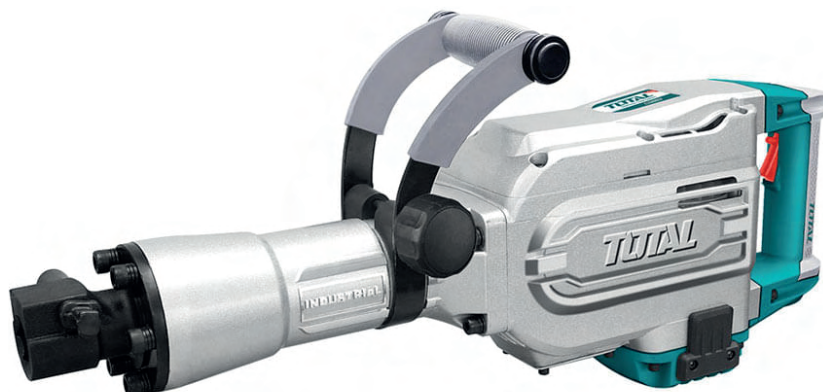

## Caladora Eléctrica De 570 W

**605254** **UTS206656**

Velocidad sin carga 800-3000 rpm  
 Corte madera 65mmAcero 8mm  
 Función de péndulo de 4 pasos  
 Base de aluminio  
 Trae (3) piezas de hojas sierra



## Caladora Eléctrica de 800 W

**605265** **UTS2081006**

Voltaje: 110-120v ~ 60hz.  
 Velocidad sin carga: 800-3000 rpm.  
 Capacidad de corte: madera: 4».  
 Acero: 3/8» función de péndulo de 4 pasos.  
 Base de aluminio.  
 Trae 5 piezas de hojas de sierra



**INDUSTRIAL**



## Router Eléctrico 1600W 2200 Rpm

**605257** **UTR111216**

Para espárragos de 1/4"» – 1/2"»

Voltaje: 110-120v~50/60hz

Potencia: 1600w

Velocidad sin carga: 22000/min

Capacidad de perforado: 0-60mm

Diámetro de puntas: 1/4"», 1/2"»

Incluye

(1) guía cerca de aluminio

(1) guía paralela

(1) escobilla de carbón extra



INDUSTRIAL

**605258** **UTR111226**

## Router Eléctrico 2200W

Para espárragos de 1/4"»» – 1/2"»»

Voltaje 110-120V~50/60Hz

Potencia 2200W

Velocidad sin carga 9000-23000rpm

Capacidad de perforado 0-60mm

Diámetro de puntas 1/4"»», 1/2"»»

Incluye

(1) Anillo adaptador

(1) Valla guía de aluminio

(1) Guía paralela

(1) Escobilla de carbón extra

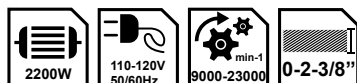

INDUSTRIAL

## Pistola Silicona 100W

**605259** **UTT101116**

Incluye 2 barras de silicona

Diámetro de barra 11.2 mm

Voltaje 110-120 v ~ 50 / 60hz

Potencia de entrada 20 w (100 w)

Capacidad de pegado 13-18g / min

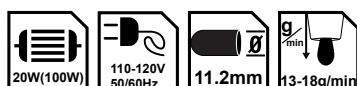

INDUSTRIAL

## Cortadora De Concreto Industrial 1500w

**605268** **UTWLC1256**

Voltaje 110-120v~50/60hz

Potencia 1500w

Diámetro del disco de corte: 5"

Profundidad de corte: 3-29mm

Ancho de corte 8-30mm

Incluye

(1) mango auxiliar

(1) escobilla de carbón extra

(4) discos de corte

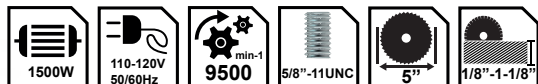

INDUSTRIAL

## Rotomartillo 1050W

**216752** **UTS100806**

Con potencia de 750w

Velocidad sin carga de 900-3300rpm

Capacidad de corte madera 4-1/2"

Acero 5/16»

Aluminio 1/2",sds,

Incluye:

Hoja sierra para madera

Hoja sierra para metal.



## Lijadora Orbital 320W

**605255** **UTF2031256**

Voltaje 110-120V~50/60Hz

Potencia 320W

Velocidad sin carga 12000/min

Diámetro de almohadilla 125mm (5»)

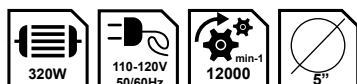

## Pistola Para Pintar 500W

**460321** **UTT5006**

Potencia de 500w  
 Flujo máximo 380 ml / min  
 Capacidad de envase 800ml  
 Cable de eléctrico de 2m  
 Incluye aguja de mantenimiento  
 Copa de medida, y correa  
 Presión de pulverización 0.1-0.2 bar  
 Viscosidad máxima de la pintura 50din-s

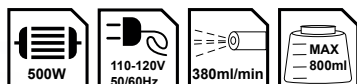

INDUSTRIAL

## Aspiradora Blower 400W Con Cable

**605262** **UTB2046**

Potencia 400W  
 Min Velocidad máx. de soplado: 3.0m<sup>3</sup>/min  
 Incluye bolsa de polvo  
 Fase monofásico  
 Voltaje 110-120V~50/60Hz  
 Velocidad Velocidad sin carga: 14000/min



## Aspiradora Blower 600W

**605263** **UTB2066**

Velocidad sin carga 16.000 rpm  
 Voltaje 110-120V AC 50/60 Hz  
 Capacidad caudal 3.5m<sup>3</sup> /min  
 Incluye bolsa para polvo

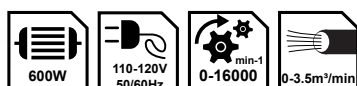

INDUSTRIAL

## Sierra Sable Reciproca A Bateria 20V

**605232** **TRSLI1151**

Velocidad: 0-2800 rpm  
 Capacidad de corte:  
 Metal: 8mm  
 Madera: 115mm  
 Incluye 1 hoja de sierra para metal  
 18 dientes (TPI), y una para madera  
 6 dientes (TPI)



## Soldador Cautin Inalambrico 40 Wts 20 Volt

**605215** **TSILI2001**

Bateria De 20 V  
 Potencia De Entrada 40 W  
 No Incluye Bateria Ni Cargador  
 Tiempo De Pre calentamiento 3 A 5 Minutos



## Soplador Aspirador Inalámbrico 20v

**605234** **TABLI2001**

Voltaje 20V  
 Amperaje 2.0Ah  
 Incluye (1) bolsa de polvo  
 Capacidad Soplar o aspirar aire  
 Velocidad Velocidad sin carga 10000-12500-17000/min



## Sopladora Inalámbrica Económica

**605213** **TABLI20018**

Voltaje 20V  
 Volumen de aire máx 2.7m<sup>3</sup>/min  
 Batería y cargador no incluidos  
 Velocidad sin carga 0-9000/0-18000rpm

**P20S**

Battery and charger  
**NOT** included



## Sopladora De Hojas Inalambrica 20v

**605222** **TABLI2002**

Potencia 1500 Rpm  
 Batería Litio  
 Velocidad Máx. Aire 38 M/S  
 No Incluye Batería Ni Cargador  
 Volumen De Desplazamiento De Aire 8.5M3/Min

**P20S**



\*Batería y cargador no incluido



## Cepillo Electrico De Madera Industrial 1050W

**605256** **UTL1108236**

Voltaje 110-120V~60Hz  
 Potencia de entrada 1050W  
 Velocidad en vacío 16000rpm  
 Cepillado anchura 3-1/4"  
 Cepillado profundidad 1/8"  
 Base de aluminio resistente  
 Encendido Gatillo



## Compresor De Aire Automático Dc 12V

**605285** **TTAC1406**

Corriente 10 A. Para Carro  
 Presión Max. 140 Psi (10 Bar)  
 Flujo De Aire Max. 35 L / Min  
 Trae 1 Luz Led  
 Trae 1 Pieza De Clips De Baterías. Trae 4 Adap  
 Trae Un Encendedor De Cigarrillos Con Cable De 3M



## Acolilladora Inalambrica 8-1/4 Sin Bateria

**TOTAL**  
 One-Stop Tools Station

**605216** **TMS2001**

Velocidad : 3000rpm  
 Corte 0-45°: 120x34mm  
 Corte 45°-0 : 83x60mm  
 Corte 45°-45°:83x34mm  
 Capacidad m x. de corte: 120×60 mm  
 Tamaño de la hoja: 210 mm (8-1/4") 25.4mm



## Pistola Spray. Boquilla 1.3Mm

**605283** **TAT10605**

Capacidad De Pintura 600Cc  
 Presion De Operación 2.0Bar  
 Boquillas Opcionales De 1.5-2.0 Mm  
 Ajuste De Ancho De Salida 180-260Mm  
 Con Conectores Tipo Europa, Usa, Nitto E Italia  
 Adecuado Para Capa De Acabado Y Pintar Autos





## Portaelectrodos 500Ah



Copper

**605277** **TWAH5006**

Heavy dutty



## Cargador De Bateria / 12v – 24v / 110v-220v Ac

**605270** **UTBC1601**

- Amperaje 1.7a fusible 5a
- Salida 8/5a fusible 20a
- Cantidad x empaque carga baterías en 12 y 24v
- Selector para carga normal
- Carga rápida
- Frecuencia 60hz
- Garantía 1 año
- Peso (kg) 7.275 kg
- Voltaje 110v / 60hz salida 12/24v



## Pistola Spray, Boquilla Standard 1.5mm

**605280** **TAT10401**

- Entrada de aire 1/4"
- Diametro de boquilla 1.5mm
- Diametro opcional de la boquilla 1.5-2.0mm
- Presion de aire recomendada 3.0-4.0bar(43.5-58psi)
- maxima presion de aire 3.5bar(50psi)
- capacidad de pintura 400cc
- Consumo de aire promedio 119-201l/min(4.2-7.1cfm)



INDUSTRIAL

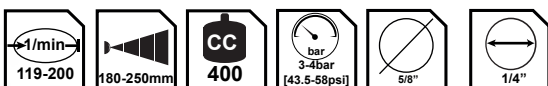

## Pistola Spray Tamaño De La Boquilla 215 Mm

**605284** **TAT20751**

Capacidad de lavado 0.75L  
 Presión de operación 4bar  
 Embalado por caja de color

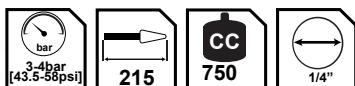

## Pistola Rociadora 1000Cc

**605286** **TAT11001**

Boquilla 1.5 mm  
 Ancho de spray regulable entre 140-180 mm  
 Capacidad 1000cc  
 Usado para capa base  
 Presión operativa 3-4 bar



## Pistola Neumática Para Inflar Llantas

**605287** **TAT11601**

Máxima presión: 12Bar (174PSI)  
 Regulación manómetro 0-12 bar  
 Acople automático 1/4"  
 Latiguillo 35 cm  
 Peso 0,5 kg

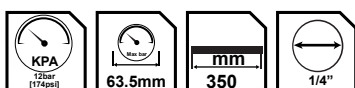

## Pistola De Pintura Para Compresor

**605281** **TAT11002**

Capacidad 1000 cc  
Boq. opcionales 1.4-2.5mm  
Ancho de aplicación 200-250mm  
Medida de Boq.1.8mm



## Pistola Spray De Gravedad Hvp

**605282** **TAT10601**

Capacidad 600cc boquilla de 1.4 mm  
Características HVLP  
dB 83.3  
Diámetro toma de aire 1/4"  
Presión máxima de trabajo 8.3 bar - 102 psi  
Ancho de trabajo: 18 - 25 cm  
Consumo de aire promedio 119 - 201 l/min  
Presión de trabajo 2 - 3.5 bar / 29 - 50 psi



## Pistola De Impacto Neumatica 1/2" 610 N.M

**605288** **TAT40122**

Velocidad sin carga 7000/min  
Máx torque 610 nm (450ft)  
Presión máxima 6.2 bar (90psi)  
Flujo de aire 142.5 l / min (5.0 cfm)  
Entrada de aire 1/4"  
Manguera de aire 3/8"  
Incluye 3 piezas de sockets (17 mm, 19 mm, 21 mm)

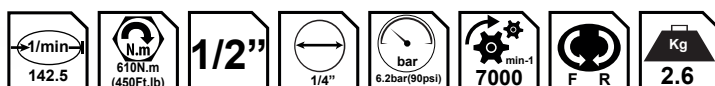

INDUSTRIAL

## Pistola De Impacto Neumatica 3/4" 1600 N.M

**605289** **TAT40342**

Velocidad max 4000 rpm  
 Torque max. 1600 nm (1180 ft )  
 mecanismo de doble martillo  
 Con conector universal  
 Consumo de aire 256 l / min ( 9cfm )  
 presión de aire 6.2 bar ( 90 psi )  
 Longitud 234 mm ( 9.2» )  
 entrada de aire 3/8»  
 Manguera de aire 1/2»

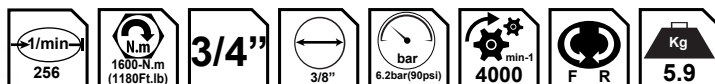

## Lijadora De Aire 6" (150Mm) 6.3 Bar (90Psi)

**605272** **TAT91501**

Velocidad max. 10000 rpm  
 Manguera de aire ( id ) 3/8»  
 Salida de aire 2.8 cfm ( 79.2 l / min )  
 presión de aire 90 psi ( 6.3 bar )  
 orbital diámetro de entrada de aire ( pt ) 1/4»

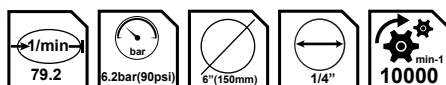

## Llave De Impacto Neumática 1"

**605290** **TAT40111**

Velocidad sin carga:3600 rpm  
 Max.Torque 3100nm(2300ft)  
 air consumption:1019l/min(36cfm)  
 Anvil:200mm(8")  
 capacidad del perno:45mm (1-3/4")  
 Entrada:1/2"  
 Manguera:1/2"

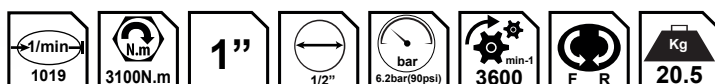

## Lubricador De Grasa Pneumatico

**605499** **THT118302**

Longitud: manguera 5m

Presión: 50:1 6-8 bar

Medida: 330x430mm

850 g/min conector 1/4"

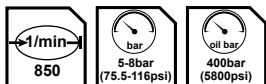

## Auto Compresor De Aire Dc12-13

**605279** **TTAC2506**

Voltaje 12 v

presión máxima 110psi (10bar)

flujo de aire máximo 45 l/min

Corriente nominal 18a

Peso 2,4 kg



## Engrapadora Neumática 2 En 1 (Clava Y Engrapa)

**605273** **TAT81501**

Carga hasta 100 pcs

Medidas de clavos 15-50mm

Ga18,1.25x1.0mm

Grapas de 5.7mm

Presión de trabajo 0.4-0.7mpa(60-100psi)

incluye 1000 clavos y 1000 grapas

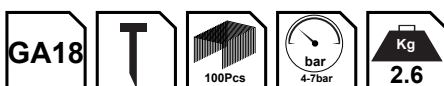

## Cable Emergencia Para Baterías Con Lampara Led

**605271** **PBCA16008L**

Corriente 600 ampe  
Abrazadera 18x11 cm  
Para emisiones  $\leq 4.5l$  car  
Longitud del cable 3 m  
material del cable recubierto de cobre  
Diámetro exterior del cable 10mm



## Hidrolavadora De Alta Presión 1400W 1900 PSI

**605422** **UTGT11316**

Encendido Switch giratorio  
Flujo máximo 5.5L/min  
Manguera de alta presión de 5 mts de largo  
Fase Monofásico  
Frecuencia 50/60Hz  
Motor 100% de Alambre de Cobre  
Bomba de metal de alta calidad



## Hidrolavadora De Alta Presión 1800W 2200 PSI

**605423** **UTGT11356**

Potencia de 1800W  
Voltaje de 110 – 120V~50/60Hz.  
Su presión máxima es de 150 bar (2200psi)  
Flujo máximo es de 6.0L/min  
Incluye una pistola de agua  
Manguera de 5m  
Sistema de apagado automático

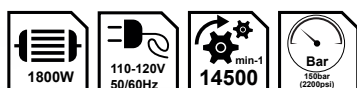

## Mini MotoTool 130W

605666

UTG501032

Potencia 130W  
 Velocidad variable  
 Frecuencia 50/60Hz  
 100 piezas en accesorios  
 Voltaje 110-120V~50/60Hz  
 Tamaño Tamaño de cuello 3.2mm  
 Velocidad sin carga 10000-32000/min



## Lámpara De Trabajo

216777

TWLI35261

Brillo 300 lúmenes  
 Peso 540g



## Portaelectrodo Para Soldar 300 AMP

605276

TWAH3006

Copper

Corriente nominal 300 ah  
 Adecuado para la maquina de soldar mma



## Alicate Punta Larga 6"



**605556**

**THT220606S**



## Kit 3 Alicates De Combinación Aislados 1,000 Voltios



**605557**

**THT2K0302**



**Cr-V**

## Alicate De Combinacion Aislado Probados En 10,000Voltios



**605317**

**THTIP181**





## Alicate De Punta Larga Aislado 8"/200Mm Cr-V

**605319** **THTIP381**

Probados En 1000Voltios



## Alicate Aislado 1000 Vol Cortafrio Lateral

**605315** **THTIP2261**

Probados En 1000Voltios

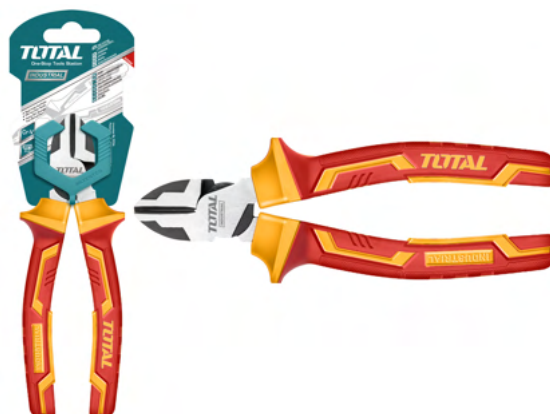

## Alicate Aislado 1000 Vol Cortafrio Lateral (Inmersion)

**605318** **THTIP261**

Probados En 1000Voltios



## Alicate Aislado 1000 Vol Pinza De Punta Larga 8"

**605450** **THTIP2381**

Soporta 1000 V  
De Mango Aislado  
Acabado Negro Pulido

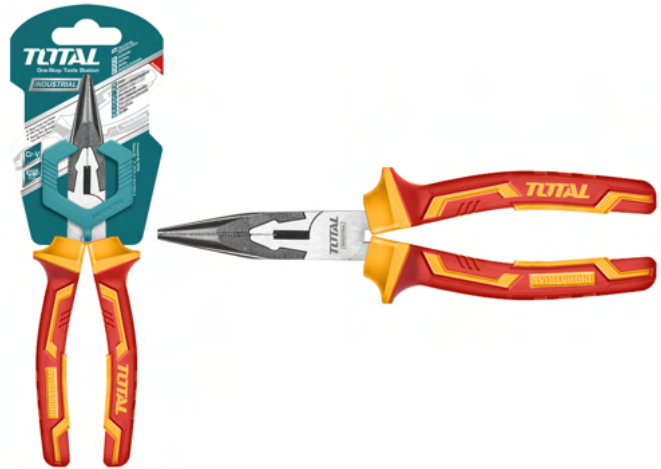

## Alicate Aislado 1000 Vol Pinza De Punta Larga 15"

**605316** **THTIP2361**

Soporta 1000 V

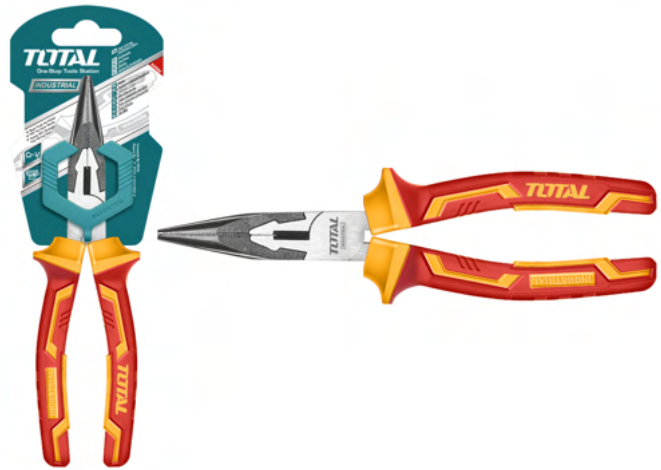

## Alicate Aislado 1000 Volt 6" Electricista

**605449** **THTIP2161**

Soporta 1000 V

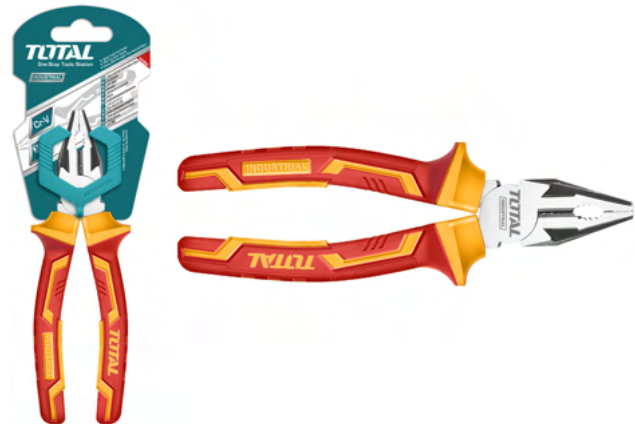

## Alicate Aislado 1000 Volts 8" Electricista

**605314** **THTIP2181**

Soporta 1000 V



## Alicate Cortafrio Lateral 6"

**605447** **THT130606P**

Tamaño: 6 «/ 160 mm  
Mango de dos colores



## Alicate Cortafrio Lateral Indust 7"

**605448** **THT27716**

Medidas 6"/160mm  
Material: Cromo-Vanadio



## Alicate Cortafrio Lateral Industrial 6"

**605312**
**THT230606S**

De alto apalancamiento  
 Ahorran el 30% de la fuerza aplicada  
 Acabado pulido en color negro



## Alicate Cortafrio Y Pinza 3 Pcs Industrial

**605313**
**THT2K0301**

Mango de dos colores  
 Presentación en colgador  
 Incluye alicate universal de 200 mm (8")  
 Alicate de punta larga de 160 mm (6")  
 Alicate de corte diagonal de 160 mm (6")  
 Cromo vanadio, acabado en negro y pulido tpr



## Alicate Electricista Industrial 9.5"

**605311**
**THT210906S**

Acabado pulido en color negro  
 De alto apalancamiento ahorran el 30% de la fuerza aplicada



## Alicate Electricista Universal 8"

**605307** **THT110806P**

Pulido. Mango De Dos Colores



## Alicate Pinza De Punta Industrial 8"

**605562** **THT220806S**

De Alto Apalancamiento  
Reduce En 30% La Fuerza A Aplicar



## Alicate Pinza Mini Pinzas Para Pines Jgo 4 Pz De 7"

**605690** **THTJ214042**

Embalaje 5 piezas



## Alicate Pinza Pelacable Multiuso 10"

**605324** **THT15101**

Peso 300gr  
Talla 254 mm  
Corte de cobre m2.6 - m5

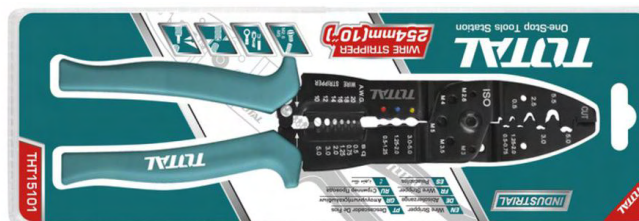

## Alicate Pinza Punta Larga 8"

**605309** **THT220806**

Cromo Vanadio  
Empuñadura Soft Grip  
Acabado negro y pulido  
Tamaño: 8 pulgadas (200mm)  
Mango de mayor tamaño con doble goma



## Cinzel Agudo Con Protector 5/8" X 10"

**605355** **THT4221026**

Mango 16 Mm Largo 250 Mm  
Alta Calidad Igual A Stanley

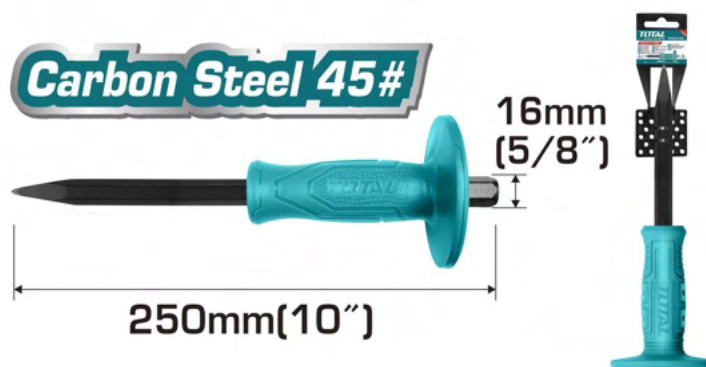

## Alicate De Punta Larga 6"/160Mm



**605308**

**THT120606P**



## Pinzas Surtidas X4 Piezas 180mm/7"



**605325**

**THT114041**



## Alicate aislado corte diagonal 6" ( 160 mm)



**605318**

**THTTIP261**

Capacidad 10000 V

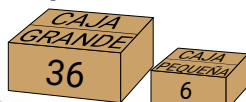

## Alicate De Punta Larga Aislado 8"/200Mm



**605319** THTTIP381

Probado en 10,000Voltios



## Llave De Tubo 8" Forjada Acero Alta Calidad



**605326** THT170806



## Llave De Tubo 12" Forjada Acero Alta Calidad



**605327** THT171206





## Llave De Tubo 14" Forjada Acero Alta Calidad



**605451** **THT171146**

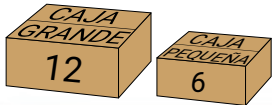

## Llave De Tubo 24" Forjada Acero Alta Calidad



**605328** **THT171246**

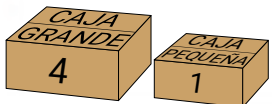

## Llave De Tubo 36" Forjada Acero Alta Calidad



**605452** **THT171366**

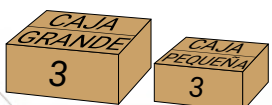

### Llave Tubo De 48 "



**605564** THT171486

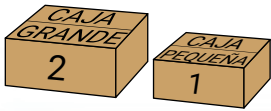

### Llave Tubo De Aluminio Total 18 " Aluminum Handle



**605656** THTAL17186

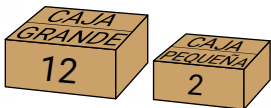

### Cizalla Mini 8



**605566** THT11386

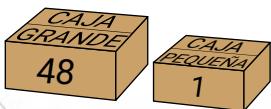

## Cizalla 14" Cr-v. Alicate Para Cortar Alambre Y Malla



**605454** **THT113146**

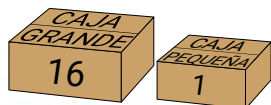

## Cizalla Manual De 30»



**605331** **THT113306**

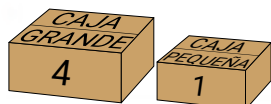

## Llave De Tubo 12" Forjada Acero Alta Calidad



**605455** **THT113306**

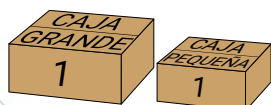

## Alicate Pela Cables 8.5"



605560

THT15851



## Alicate Para Crimpar Conectores Eléctricos 0.5-6Mm<sup>2</sup>



**CRIMPING RANGE:**  
**0.5-6mm<sup>2</sup>**



Non-insulated tabs & receptacles

650562

THCPC0506



## Juego De Alicates Para Anillos De Retencion De 7"/180 Mm

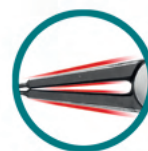
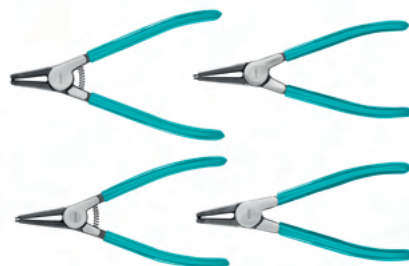

More Stronger **5**

605563

THTJ214041

### Cizalla 18"



**605567** **THT113186**

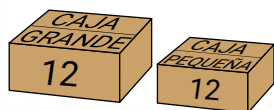

### Cizalla 42"



**605568** **THT113426**

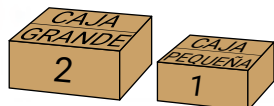

### Cortador De Tubo De Cobre Y Alumnio Corta Hasta 32 Mm



**605569** **THT53321**

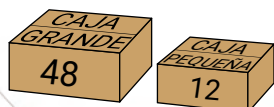

## Llave De Tubo 1" Sueca De Trabajo Pesado De 45°



**605453** **THT172011**

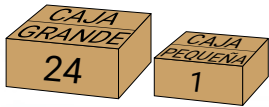

## Pinza Para Separar Revestimiento De Alambre 10"/254mm



**605334** **THT264100**

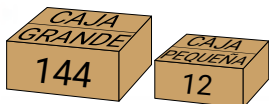

## Juego Destornillador Puntas 6 En 1 Cr-v

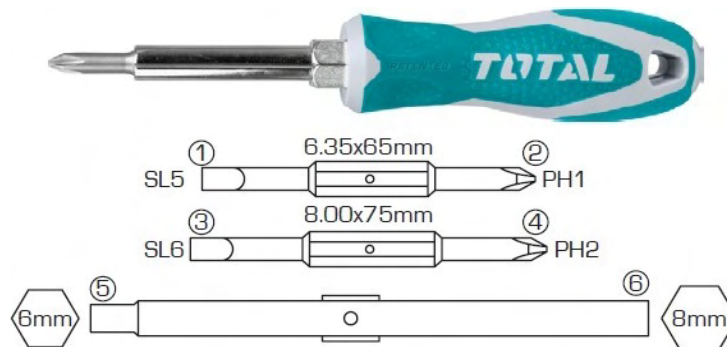

**605339** **THT2506076**

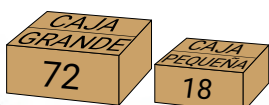

## Hombresolo Curvo 10"

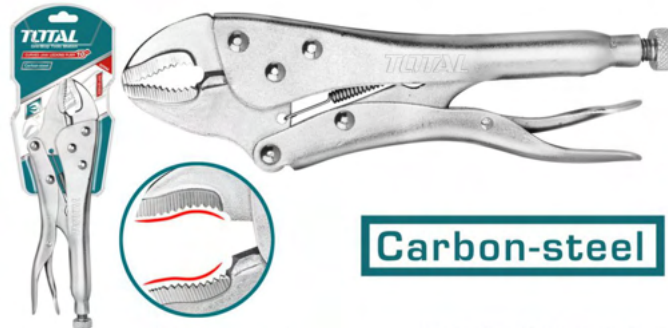

605320

THT191003



## Hombresolo 10" Plano



605321

THT191002



## Alicate De Presión Mandíbula Plano Cr-V 10"



605322

THT191005



## Alicate De Presión Para Soldador

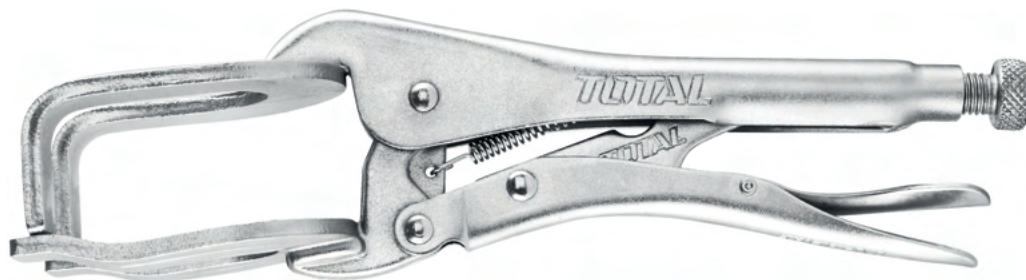

**605558**

**THT1921003**



## Alicate De Presion Tipo C Abrazadera Con Anillo De Amarre

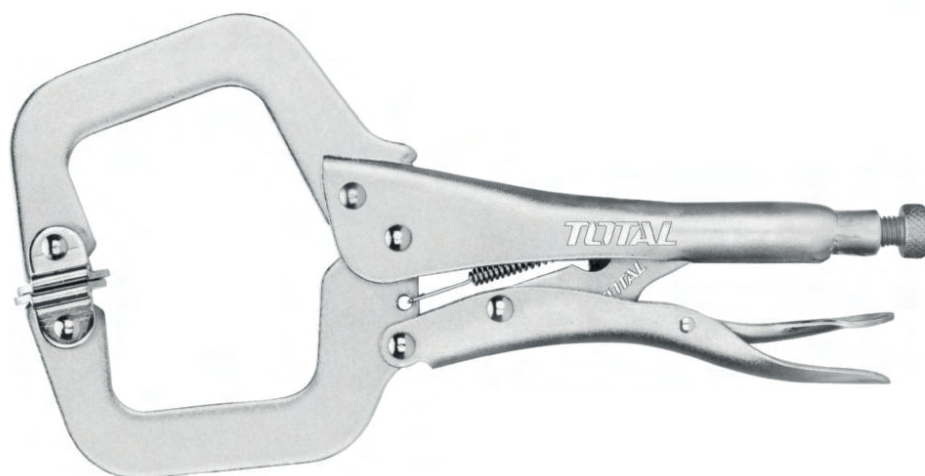

**605323**

**THT111113**



## Separador De Alambre De 0.5 A 6 Mm



**605559**

**THT15606**





## Llave Boca Fija Jgo 8 Piz 6 Mm A 22 Mm

325904

THT102386



## Llave Bristol Mango En T 2 Mm A 10 Mm 8 Piz

605689

THHW80816



## Llave Bristol Mango En T Tipo Bola

605691

THHW80826



## Llave Bristol T. Bola 9pz 1,5-10mm Industrial

Long Arm



**605388**

**THT106291**

## Llave Combinada Jgo 6-19 Mm Industrial 8pz



**325903**

**THT102286-I**

6mm 8mm 10mm **13mm**  
14mm 15mm 17mm 19mm

## Llave Combinada Ratchet Jgo 19-32mm Industrial 6pz



**605502**

**THT102RK061**

## Llave Combinada Tipo Ratchet 8 Mm

**325906****TCSPAR081**

## Llave Combinada Tipo Ratchet 10 Mm

**325907****TCSPAR101**

## Llave Combinada Tipo Ratchet 11 Mm

**325908****TCSPAR111**

## Llave Combinada Tipo Ratchet 12 Mm

**325909****TCSPAR121**

## Llave Combinada Tipo Ratchet 13 Mm

**325910****TCSPAR131**

## Llave Combinada Tipo Ratchet 14 Mm

**325911****TCSPAR141**

## Llave Combinada Tipo Ratchet 17 Mm



**325912** TCSPAR171

## Llave Combinada Tipo Ratchet 19 Mm



**325913** TCSPAR191

## Llave Combinada Tipo Ratchet 8 A 19 Mm Jgo 8 Piz



**325905** THT102RK086

## Llave Copa Impacto Larga Cte 1/2"



216759

THKISD12102L

10Pcs/Set

1/2"

CR-MO

## Llave Expansiva Picoloro 8"



605658

THT101083

## Llave T.Sueca P. Tubos De Servicio Pesado De 45 °

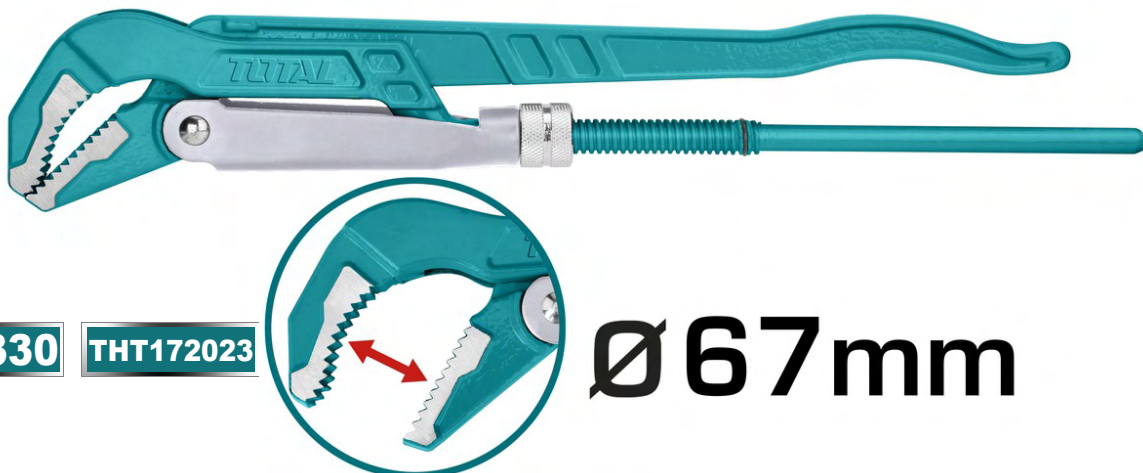

605330

THT172023

Ø 67mm

## Juego De Llaves Anulares Acodadas De 12 Pzas 6-32 mm



605627

THT1024121



## Llave Combinada Cromada Mate 20mm Largo 242mm

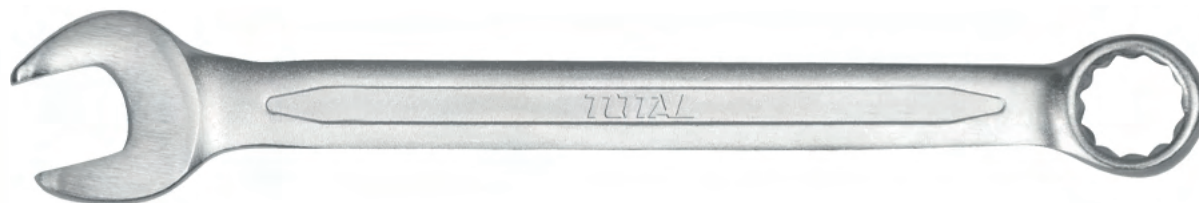

605565

TCSPA201



## Llave Ajustable 10"

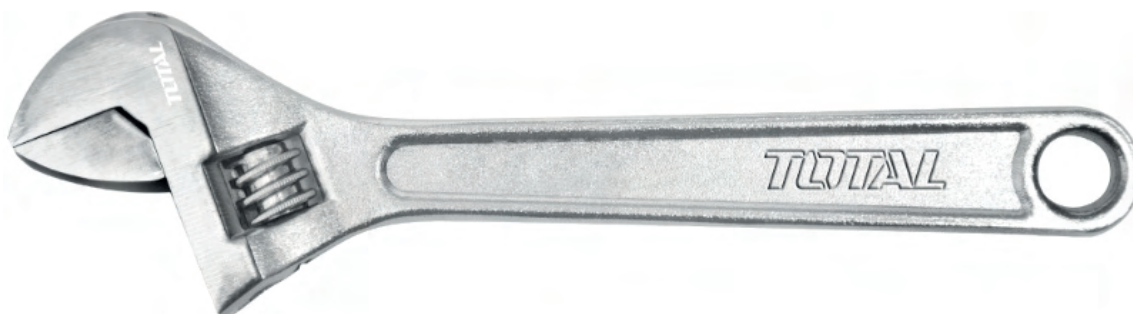

605628

THT1010103



## Llave Ajustable De 12"

**605629****THT1010123**

## Llave Ajustable de 15"

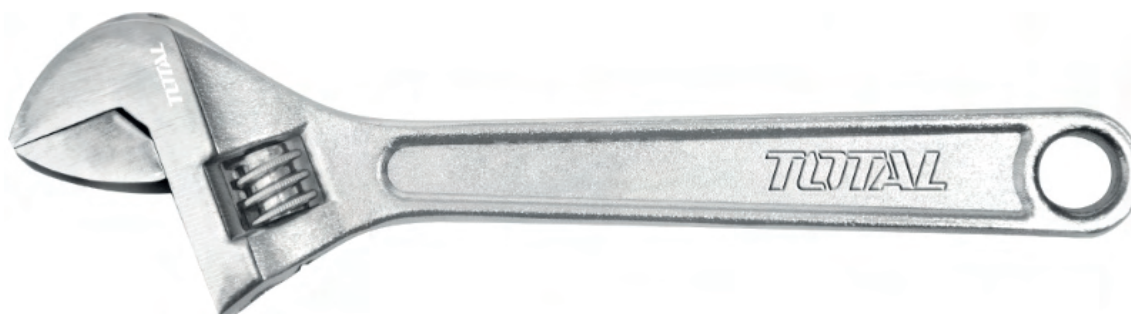
**605630****THT1010153**

## Llave Ajustable De 18"

**605631****THT1010183**



## Llave Ajustable Encauchetada 6"(150mm)

**605383****THT101066**

## Llave Ajustable Encauchetada 8" (200mm)

**605384****THT101086**

## Llave ajustable encauchetada 10" (250mm)

**605385****THT101106**

## Llave Ajustable Encauchetada 12" (300mm)



605386

THT101126



## Llave Multiuso X 2 Pzs (9-32mm) (9-14mm)



605382

THT10309328



## Extractor De 2 Mandibulas De 3" Fuerza 2000 Kg Cr-v



605353

THTGP236



## Corta Tubo Pvc Total 3-42mm Fina



**605460**

**THT53425**

CAJA  
GRANDE  
48

CAJA  
PEQUEÑA  
6

## Remachadora Manual De 10.5»



**605357**

**THT32104**

CAJA  
GRANDE  
24

CAJA  
PEQUEÑA  
4

## Remachadora Manual 10.5» Cuerpo De Aluminio



**605358**

**THT32105**

CAJA  
GRANDE  
40

CAJA  
PEQUEÑA  
10

## Remachadora De Acordeón Plegable 32»



605359

THT32321



## Llave Mixtas En Juego De 12 Piezas



605380

THT1022121



## Llave X 12 Piezas Boca Y Estría (6-32mm)



605381

THT1022122



### Extractor De 2 Mandibulas De 4" Fuerza 3000 Kg Cr-v



**605484** THTGP246

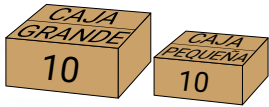

**4**

### Extractor De 2 Mandibulas De 6" Fuerza 5000 Kg Cr-v



**605354** THTGP266

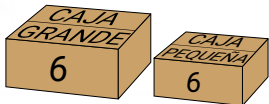

**6**

### Extractor De 3 Mandibulas De 4" Fuerza 4000 Kg Cr-v

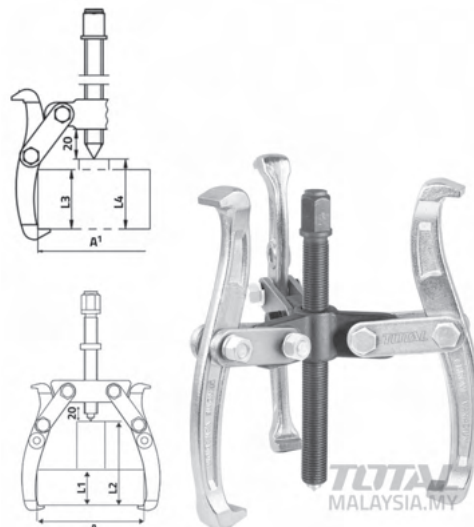

**605485** THTGP346

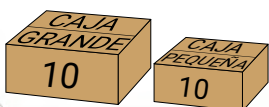

TOTAL  
MALAYSIA.MY

## Extractor De 3 Mandibulas De 6" Fuerza 6000 Kg Cr-v

**605486**   **THTGP366**

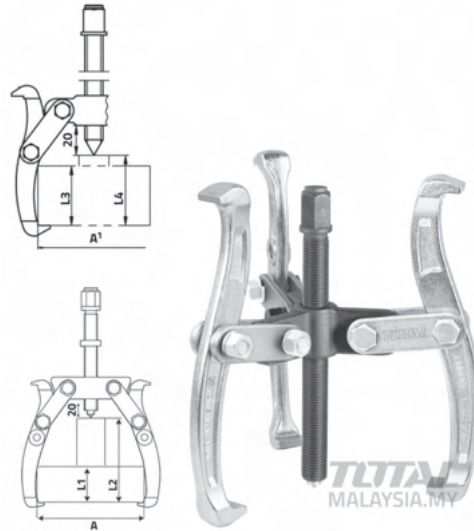
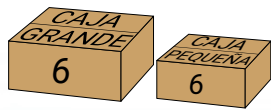

## Juego De Llaves Hexagonales De Brazo Largo De 9 Piezas

**605387**   **THT106191**

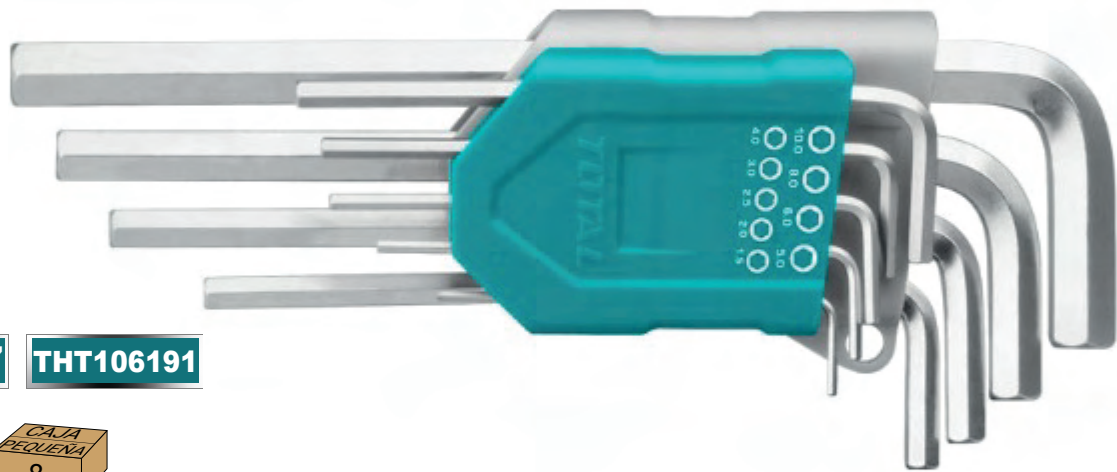
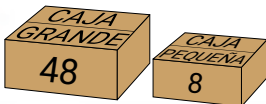

## Juego De Llaves Torx 1.5/10mm Largo De 9 Piezas

**605388**   **THT106291**

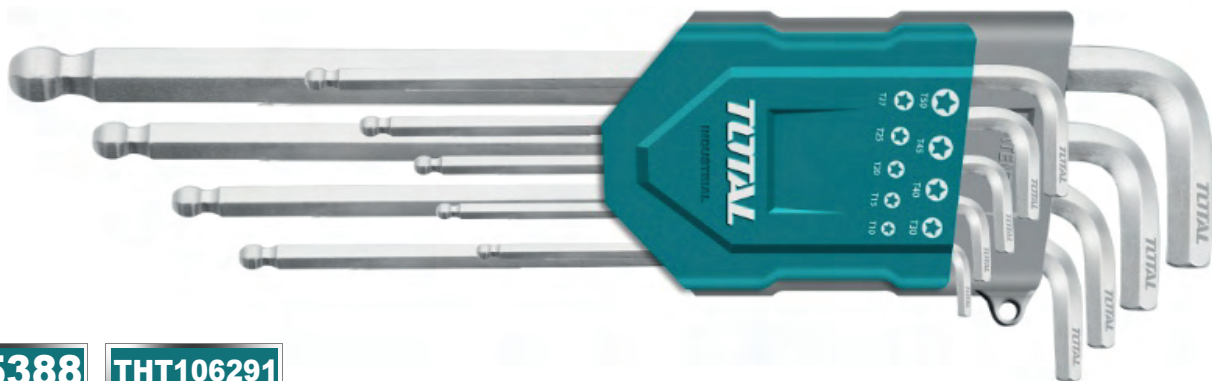
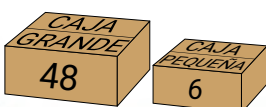

## Juego De Llaves Torx De Largo Corto De 9 Piezas



**605389**

**THT106392**



## Set De 8 Llaves Torx Estilo Navaja T9-t40 Cr-v

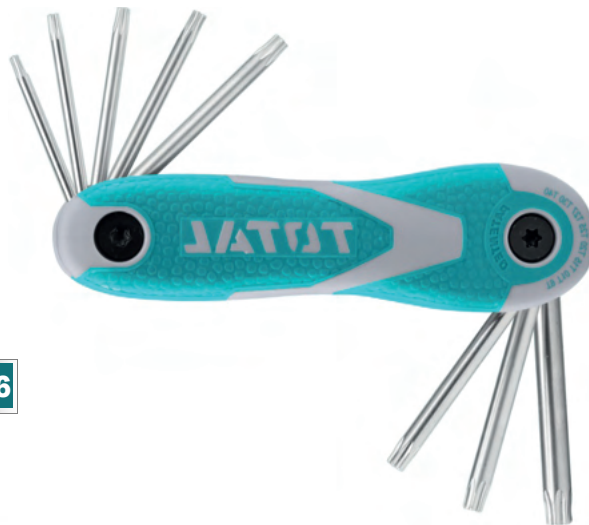

**605390**

**THT1061846**



## Ratchet 1/4" 158mm



**605392**

**THT106146**



## Ratchet De 3/8» 45t 205mm Largo Material Cr-v+cr-mo



**605393** **THT106386**

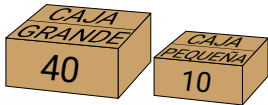

## Ratchet De 1/2» 45t 260 Mm Largo Material Cr-v+cr-mo



**605394** **THT106126**

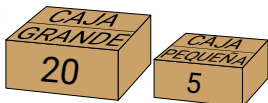

## Juego De Llaves Hexagonales Y Llaves Torx 18pzs

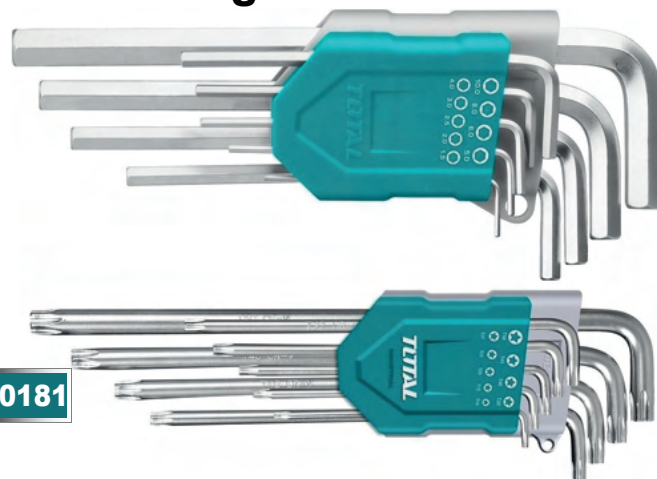

**605503** **THT106KT0181**





## Juego De Llaves Allen 8 Pzs Portátil



605632

THT1061826



## Juego De Llaves Torx Con Mango T De 8 Pzs

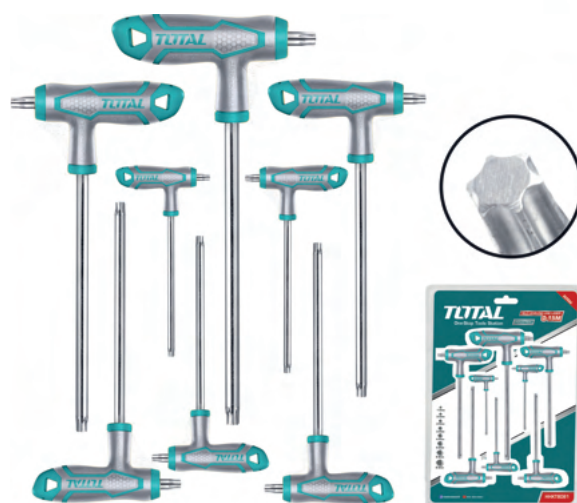

605633

THHW8083

Material:

Cr-V , Tratamiento Térmico Y Placa De Cromo

Medidas: T10X75, T15X75, T20X100,

T25X100, T30X150, T40X150, T45X200, T50X200



## Extension Barra En T Deslizante De 1/2"

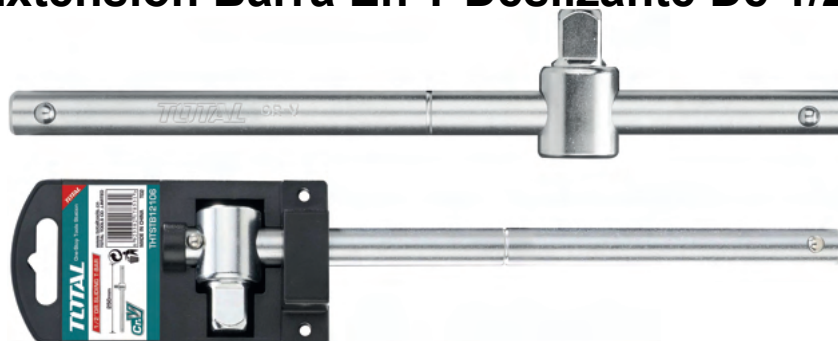

605634

THTSTB12106



## Llave Ajustable Aislada 10" 1000V



**605590** **THIADW101**



## Ratchet Con Socket Total Tools Con 24pcs



**605347** **THT141253**

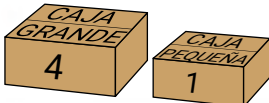

## Maletin Mixto De 12 Pcs De Puntas Para Router De 1/2"



**605662** **TACSR0102121**



## Juego De Dados Socket De 3/4" Dr

**605592** **THT341151**

De 15 piezas Cr-v (50 bv 0)  
Cromado de tratamiento térmico  
Incluye 10 dados socket de 3/4" 30-32-  
34-36-38-41-46-50-55-60 mm  
1 barra ratchet de 3/4" 24t  
1 barra extensión en t deslizante de 3/4" 520mm

CAJA  
GRANDE  
1

**3/4"**  
**15PCS/SET**  
**24T**  
**Cr-V**



## Caja De Herramientas De 97 Piezas

**605593** **THPTCS70971**

Tamaño 520\*218\*243Mm  
Bandeja 506\*215\*63Mm  
Gavetas 449\*196\*54Mm

CAJA  
GRANDE  
1

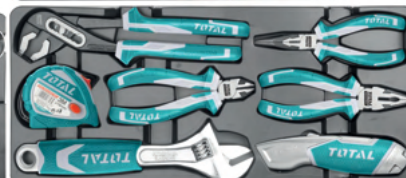

## Bolsa De Herramientas Tamaño 13"

**605594** **THT261325**

Carga Máxima 12Kg  
Con 6 Bolsillos Al Aire Libre

CAJA  
GRANDE  
40

CAJA  
PEQUEÑA  
2

**13"**



## Bolsa Para Herramientas De Cinturón L32 \* W28Cm



**605595** **THT16P1011**

Material 600D Polyester  
Para 10 Herramientas Y 2 Martillos

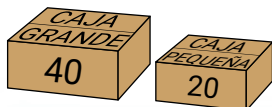

## Morral Bolso De Espalda Para Herramientas

**219786** **THBP0201**

De polyester oxford 600d  
1 bolsa con asa interior  
Tamaño 34 cm x 17 cm x 45 cm  
Marco rigido para facil apertura  
Facil acceso a bolsillos internos y externos

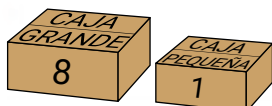

## Abrazadera en forma De G 6"



**605596** **THT13136**

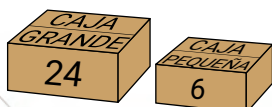

## Prensa 170kg 50 X 200mm F Abrasadera 170kg

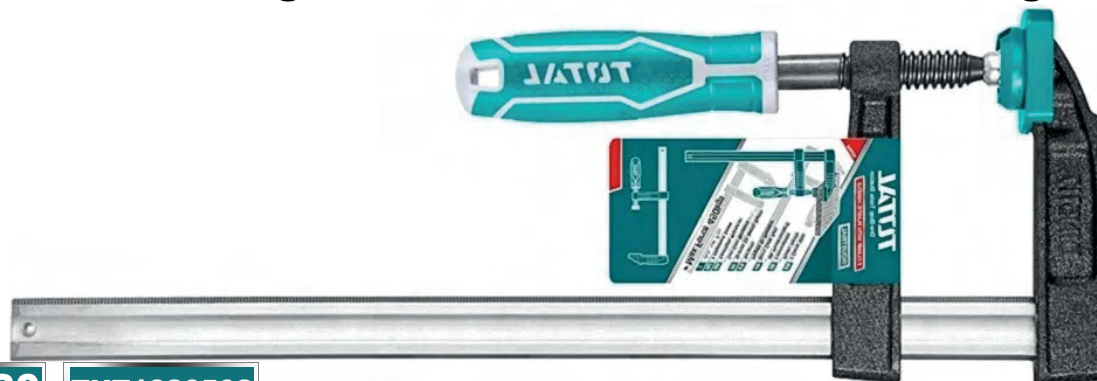

**605480** THT1320502

## Prensa 170kg 50 X 250mm F Abrasadera 170kg



**605481** THT1320503

## Prensa 270kg 50 X 250mm F Abrasadera 270kg



**605482** THT1320801



### Prensa 450Kg 120x300Mm F abrasadera 450kg



**605483** **THT1321201**

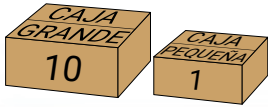

### Prensa 4" Tipo Sargento



**605351** **THT13141**

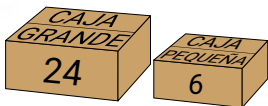

### Prensa 5" Tipo Sargento



**605352** **THT13151**

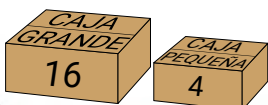

## Prensa 6" Tipo Sargento



**605479** **THT13161**

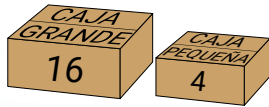

## Prensa De Mesa 6» Fuerza De 1600kg

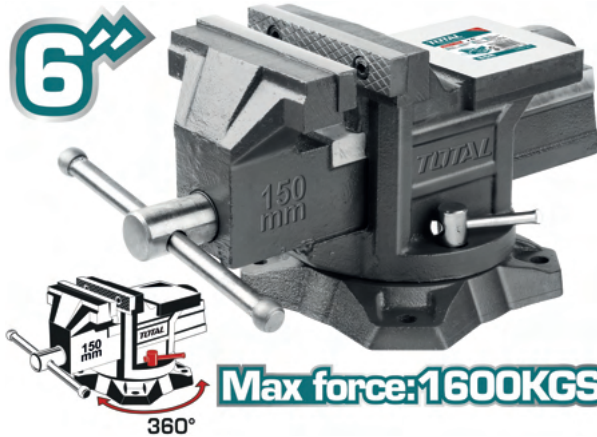

**605487** **THT6166**

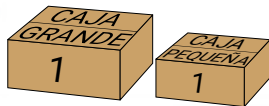

## Prensa De Mesa 8» Fuerza De 2500kg

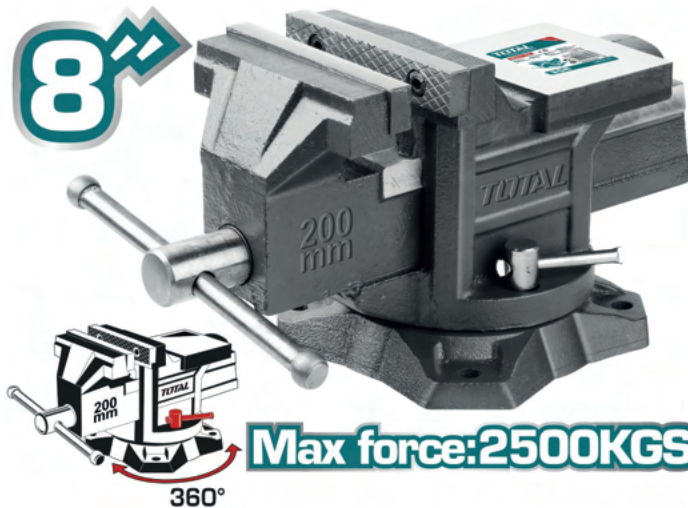

**605488** **THT6186**

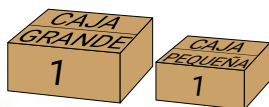

## Abrazadera En Forma G De 8"



605597

THT13186



## Prensa Tipo F 120x400 Mm



605598

THT1321202



## Prensa Sargento De Barra De 6"

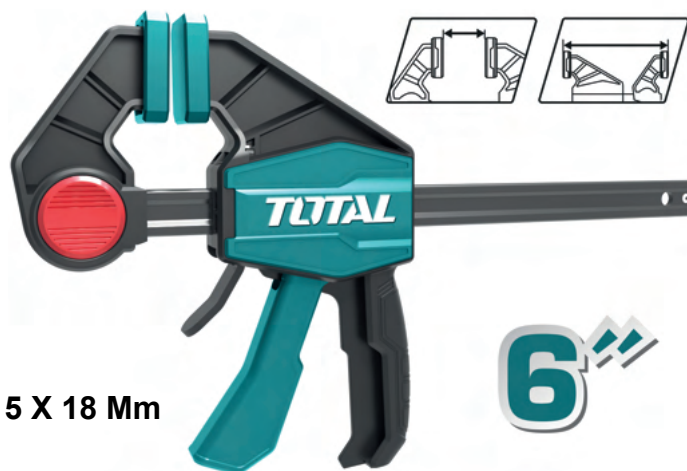

605599

THT1340601

Medidas 63 X 150 Mm

Max Fuerza De La Prensa 60 Kg

Espesor Y Ancho De La Regla De Hierro 5 X 18 Mm





### Prensa Sargento De Barra De 12"

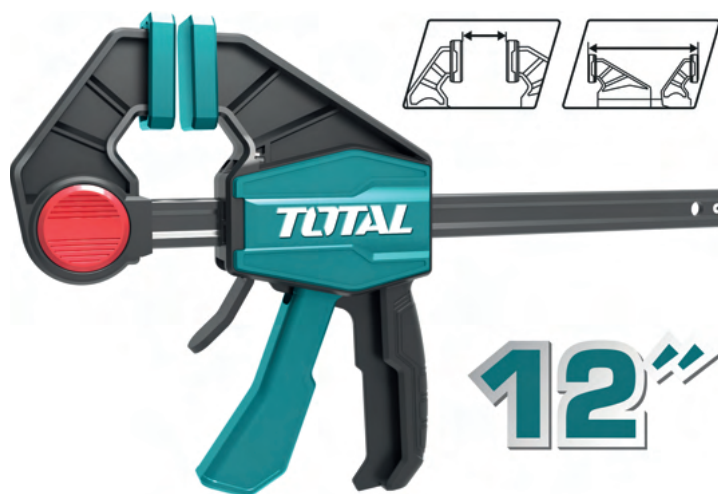

**605600** **THT1340602**

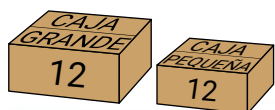

### Prensa Sargento De Barra De 18"

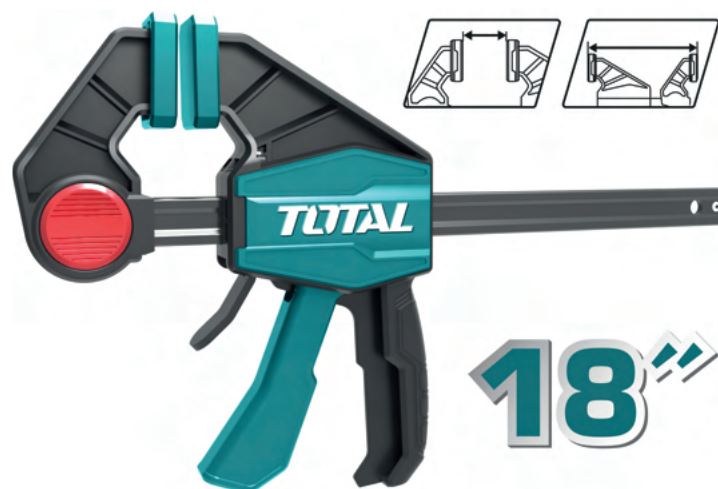

**605601** **THT1340603**

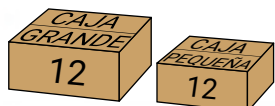

### Pinza De Resorte Para Sujecion De 4"



**605602** **THT13342**

Longitud De 110 Mm  
 Max Abertura 50 Mm  
 Fuerza De Agarre 12 Kg

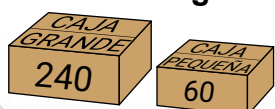

## Extractor De 3 Mandibulas 3" 3000Kg



podium racing

605659

THTGP336



## Prensa De Banco Base Giratoria

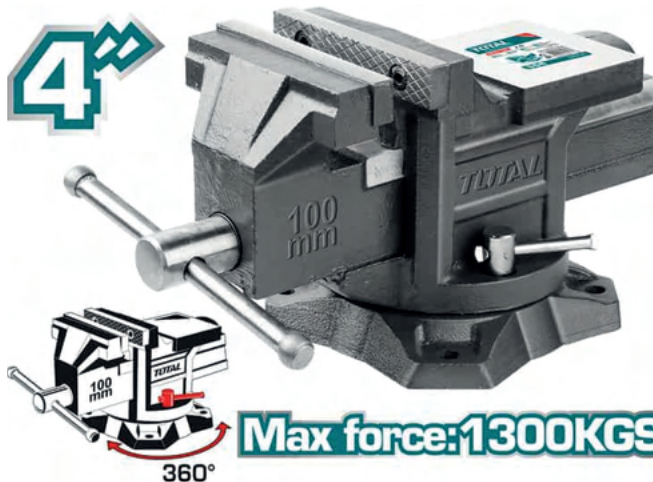

605603

THT6146



360°

Max force: 1300KGS

## Cinzel Industrial 305 mm

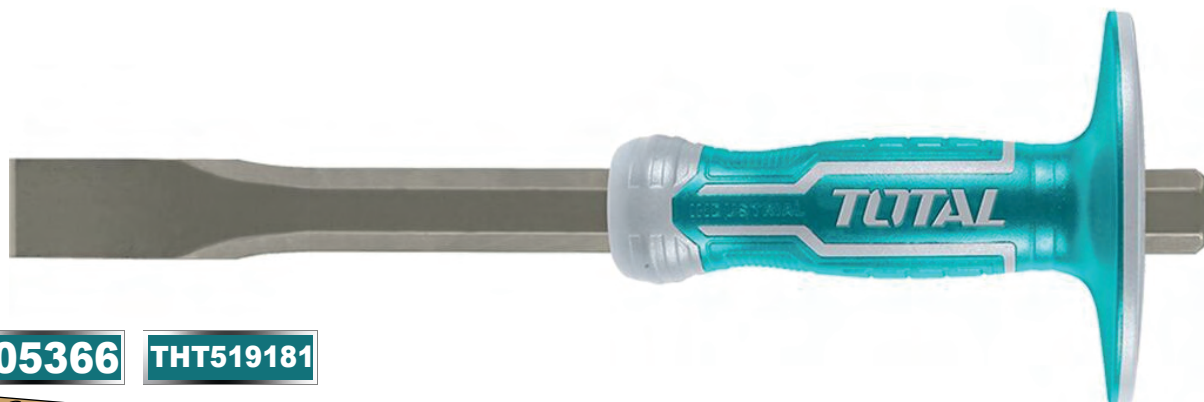

605366

THT519181



## Cinzel Frío - 305 Mm / 25 Mm



605490

THT4411219



## Cinzel De Hormigón De 4 Mm Cabeza



605491

THT4421219



305mm

## Remachadora Manual De 10.5"



605604

THT32108S



## Remachadora Manual De 10"



605605

THT32101



## Remachadora Giratoria 360 Grados 10.5"



605606

THT32106



## Remachadora 13"



605607

THT32131



## Cinzel Plano Con Protector 5/8" X 10"

**605489** **THT4211026**

Mango 16 Mm Largo 250 Mm  
Alta Calidad Igual A Stanley



## Cinzel Plano Industrial Con Protector 3/4" X 12"

**605356** **THT4411216**

Longitud 250 mm  
tamaño del mango 16 mm  
Tamaño de la cabeza 22 mm



## Cinzel Sds Max Punta Aguda 16"



**605293** **TAC1521182**

## Cinzel Sds Max Punta Pala 16"

**605294****TAC15221821**

## Cinzel Sds Plus Pala 10"

**605292****TAC15121411**

## Cinzel Sds Plus Punta 10"

**605291****TAC1511141**

## Destores Jq. 32 Pz Precisión



605472

THT250PS0321

## Destores Jg.10 Pz Aislado 1000 Volt Surtidos

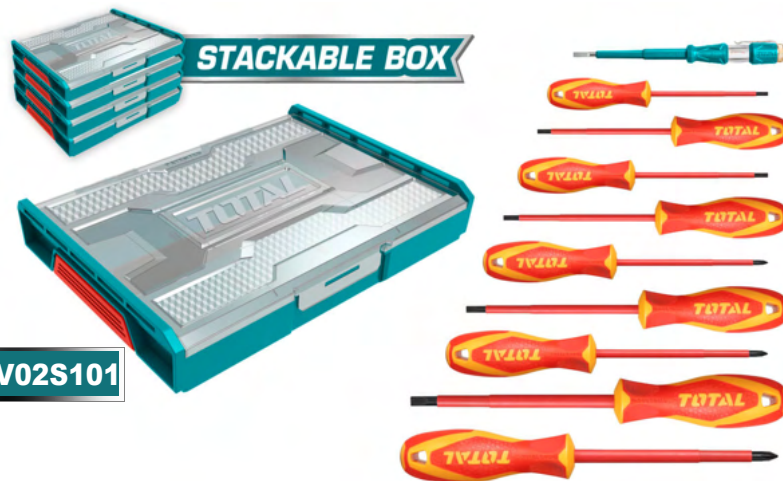

605474

THKTV02S101

## Destornillad Estrella Industrial 3/16" X 4"



240606

THT2246

## Destornillad Estrella Industrial 1/4" X 6"

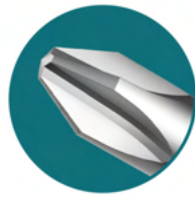

PH2x150



605588

THT26PH2150

S2



## Destornillad Estrella Industrial 3/16" X 4"



PH1x100



605468

THT26PH1100

S2



## Destornillad Estrella Industrial 5/16" X 8"



240607

THT22836



## Destornillad Estrella Liviano 1/4" X 6"



605463

THTDC2266

## Destornillad Pala Industr 1/4" X 1.1/2"



240608

THT21386

## Destornillad Pala Industri 1/4" X 5"



# SL6.5x125



605466

THT266125

# S2



## Destornillad Pala Industri 1/4" X 6"



SL6.5x150



605467

THT266150

S2



## Destornillad Pala Industri 5/16" X 8"



240610

THT21886

## Destornillad Pala Industri 5/16" X 8"



SL8x200



240611

THT268200

S2



## Destornillad Pala Industri 1/4" X 5"

**240609****THT2156**

## Destornillad Pala Liviano 1/4" X 6"

**605461****THTDC2166**

## Formones Profesional 1"

**325898****THT41256**

## Juego De Destornilladores Variado De 2 Pzas

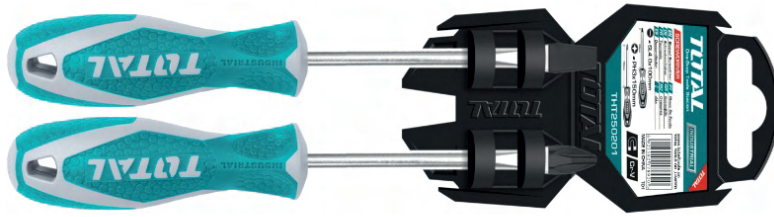

**605469** **THT250201**



## Juego De Destornilladores Variado De 2 Pzas

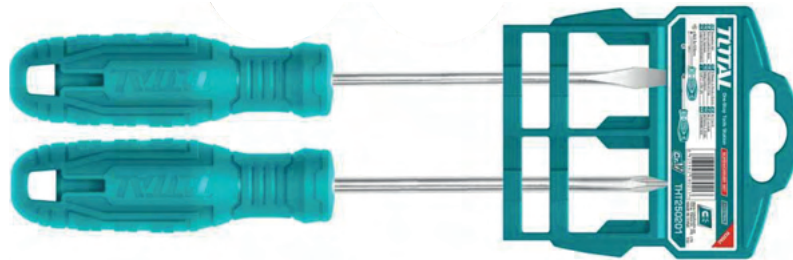

**605332** **THTDC250201**

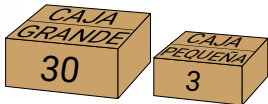

## Destornilladores Set 6 Pzs



**605464** **THTDC250601**

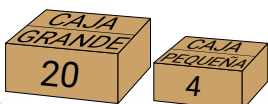

## Juego De Destornilladores X 6pzs



243270 THT250606

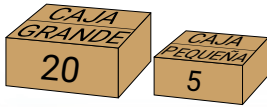

## Juego 6pza Destornilladores



605338 THTIS566

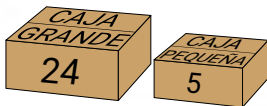

## Juego Destornillador De Precisión (7pza)



605340 THT250726

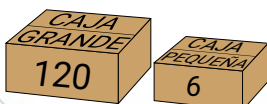

## Destornillador Flexible Con 12 Puntas Intercambiables



**605471** **THT250FL1206**

CAJA GRANDE 48  
CAJA PEQUEÑA 12

## Destornillador Ratchet 24 Piezas Intercambiables



**605470** **TACSD30246**



CAJA GRANDE 30

## Destornillador Tipo T X 24pzs



**605473** **TACSD30186**

CAJA GRANDE 36  
CAJA PEQUEÑA 18

-  SL4,SL5,SL6
-  PH1,PH2,PH3
-  PZ1,PZ2,PZ3
-  5mm,6mm,7mm  
8mm,9mm,10mm

## Formones Profesional 3/4"



**325897**

**THT41196**

## Formones Profesionales 1/4" A 1" Jg 4 Pz



**272433**

**THT41K0401**

## Hacha Mango Fibra 600 Grs

**390mm**



**605446**

**THT786006**

## Caja De Herramientas Surtida 77 Pzs



**605348** **THKTHP20776**

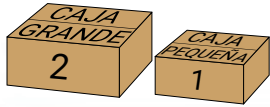

## Juego De Dados 12 Pzs Con Ratchet 1/4"



**605343** **THT14114126**

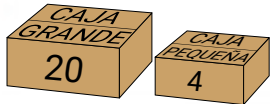

## Juego De Dados 12 Pzs Con Ratchet 1/2"

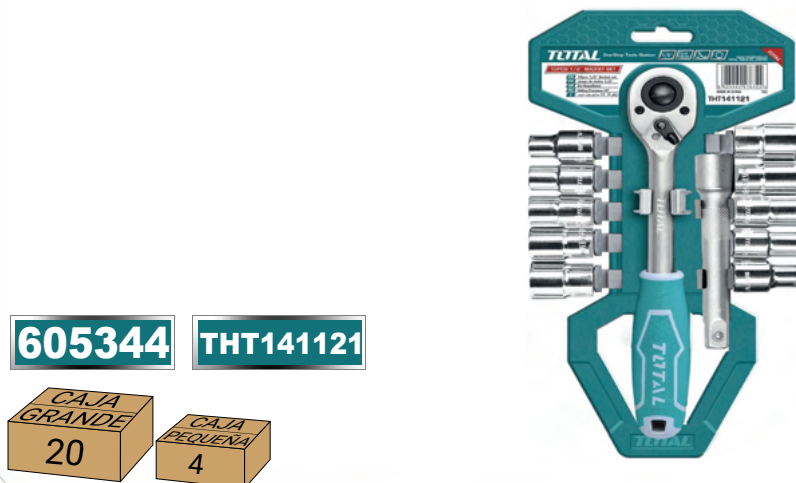

**605344** **THT141121**

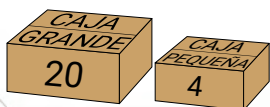



## Juego De Ratchet 25 Pcs 1/2"

**605346** **THT121251**

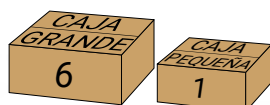

## Juego De Dados 44 Pcs 1/4" + 1/2"

**605475** **THT421441**



## Juego Ratchet Con Socket 45 Pza 1/4"

**605345** **THT141451**



## Caja De Herramientas Surtida 142 Piezas



605349

THKTHP21426



## Martillo Tratam Térmico Acero 45 # Con Mango Fibra Vidrio



**Fibreglass handle**

**500g**



**Drop forged**

605441

THT715006



## Martillo Tratam Térmico Acero 45 # Con Mango Fibra Vidrio



**Fibreglass handle**

**1000g**



**Drop forged**

605442

THT7110006



Martillo De Lapidacion Mango De Fibra 1000g



**605443** **THT7210006**



Martillo De Lapidacion Mango De Fibra 1500g



**605444** **THT7215006**

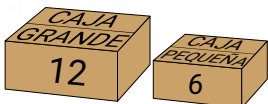

Martillo De Lapidacion Mango De Fibra 2000g



**605445** **THT7220006**



Martillo De Orejas Acero 45# Mango Fibra Vidrio 16oz



605303 THT73166

CAJA GRANDE 18  
CAJA PEQUEÑA 6

Mazo De Goma 16oz/450g Mango De Fibra De Vidrio



605304 THT761616

CAJA GRANDE 24  
CAJA PEQUEÑA 4

Mazo 8oz Blanco De Goma 8 Oz/220g 45% Goma Natural



605305 THT76836

CAJA GRANDE 40  
CAJA PEQUEÑA 6

## Mazo 16oz Blanco De Goma 16onz/450g 45% Goma Natural



**605306**

**THT761636**



## Hacha De Mano Acero 45# Mango Fibra Vidrio 600g

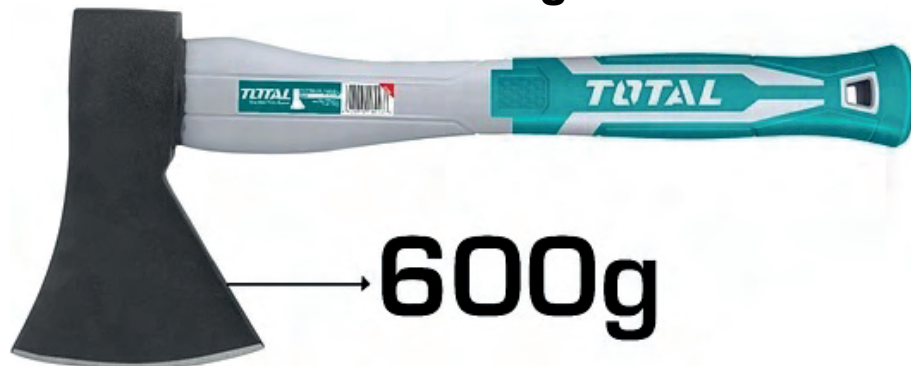

**600g**

**605446**

**THT786006**



## Cinzel De 16 Mm Cabeza Mango 16 Mm Largo



**605489**

**THT4211026**



## Destornillador Plano 40 Cr Mango Redondo



**605570**

**THTDC2156**



## Destornillador Phillips 40 Cr, Ph1, Mango Redondo 5 Mm



**605462**

**THTDC2246**



## Destornillador Phillips 40 Cr, Ph2, Mango Redondo 6 Mm



**605571**

**THTDC2256**



## Juego De 4 Destornilladores Mango Ergonomico



605572

THTDC250401

CAJA  
GRANDE  
30CAJA  
PEQUENA  
3

## Juego De Destornilladores De 10 Pcs

10Pcs/set



605333

THTDC251001

CAJA  
GRANDE  
40

## Juego De Destornilladores De 6 Piezas



605465

THGSS35061

CAJA  
GRANDE  
20CAJA  
PEQUENA  
5

## Destornillador Corto De Paleta SI 6.5Mm

# S2

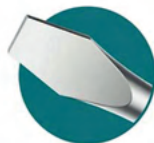
**605573**
**THT266038**

## Destornillador Corto De Estrella Ph2 6Mm

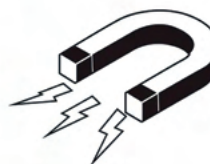

# PH2x38

**605674**
**THT26PH2038**

## Desatornillador Phillips Ph0 X 3"



# PH0x75

**605575**
**THT26PH0075**



## Desatornillador Phillips Ph1 75mm



PH1x75



605576

THT26PH1075



## Destornillador De Estrella Ph2 Diam 6.0 Mm



PH2x125



605577

THT26PH2125



## Destornillador De Estrella Ph3 Diam 8.0 Mm



PH3x200



605578

THT26PH3200



## Juego De 8 Pcs De Destornilladores Variados

**605579** **THT250608**

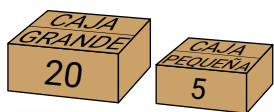

## Juego De Destornilladores 10 Unidades

**605337** **THT250610**

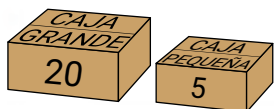

## Juego De Destornilladores Variado

**605580** **THGSS2206**

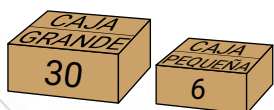

## Juego De Picos Y Ganchos De 4 Piezas



605581

TPHSK0401

CAJA  
GRANDE  
48CAJA  
PEQUEÑA  
8

## Juego De Destornilladores De Precision Variado

605583

TACSD30326

De 32 pzas

1 mango de plastico

1 soporte para brocas de 4x60mm 30 pzas

Brocas de 4x28mm sl1.5, sl2, sl2.5, sl3,

sl3.5, sl4, ph000, ph00, ph0, ph1, t4, t5,

T6, t7, t8, t9, t10, t15, t20, h0.9, h1. 3, h1.5



## Juego De Brocas Destornilladores Con Mango Tipo T

605341

TACSD30476

De 47 piezas

Incluye 35 brocas

Destornilladores de 6.35 x 25

Mm sl3 sl4 sl5 sl6 sl7 ph0 ph1x3 ph2x5

Ph3x3 pz0 pz1 pz2x2 pz3x2 t10 t15 t20

T25 t27 t30 t40 h2 h3 h4 h5 h6. 9 brocas

CAJA  
GRANDE  
24CAJA  
PEQUEÑA  
4

## Juego De 55 Pzas Brocas Con Destornillador Intercambiable

**605584 TACSD30556**

Incluye 21 Pzas 6.35X25Mm: SI4, SI5, SI6, Ph1, Ph2, Ph2, Ph2, Ph3, Pz1, Pz2, Pz3, T10, T15, T20, T25, T30, T40, H3, H4, H5, H6.  
20 Pzas 4X28Mm De Precision: SI1.5, SI2, SI2.5, SI3, Ph000, Ph00, Ph0, Ph1, T6, T7, T8, T9 T10

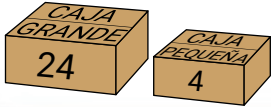

## Kit De Herramientas 7pzs



**605585 THKTHP90076**



## Juego De Herramientas De 9 Pzas



**605342 THKTHP90096**

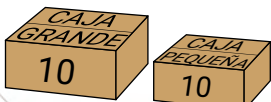

## Juego de Herramientas Manuales de 11 piezas



**605586** **THKTV02H111**

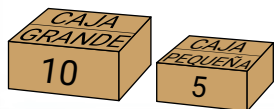

## Destornilladores de tuerca aislada de 7 piezas (6-12 mm \* 125 mm)

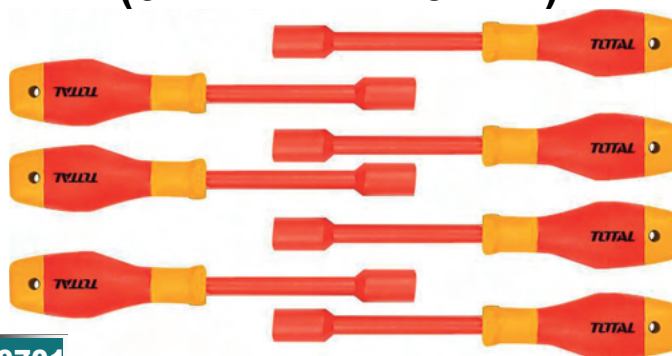

**605587** **THKISD0701**

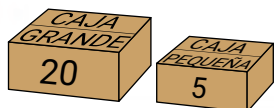

## Juego De Destornilladores Aislados De Precisión (6 Piezas)

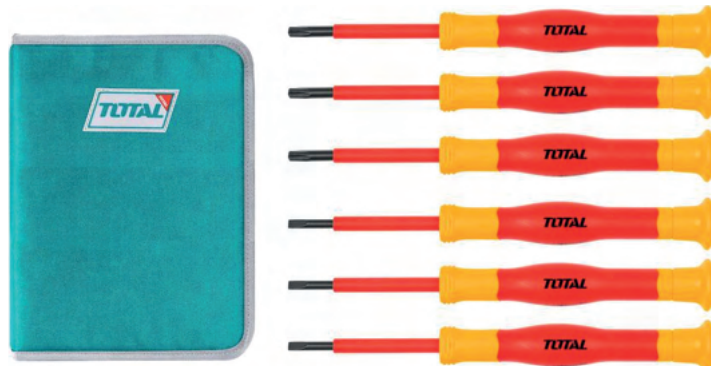

**605589** **THKIPSD0601**



## Pistola Spray Boquilla 1.5Mm

**216757**
**TAT10402**

Salida de aire 3.5-  
 Adecuado para capa base  
 Capacidad de pintura 400cc  
 Presion de operación 3-4bar  
 Boquillas opcionales de 1.5-2.0 mm  
 Ajuste de ancho de salida 180-250mm  
 Con conectores tipo europa, usa, nitto e italia

CAJA  
GRANDE  
10



## Pistola Spray Boquilla 1.3Mm

**216767**
**TAC16PH223**

Capacidad De Pintura 600Cc  
 Presion De Operación 2.0Bar  
 Boquillas Opcionales De 1.5-2.0 Mm  
 Ajuste De Ancho De Salida 180-260Mm  
 Adecuado Para Capa De Acabado Y Pintar Autos  
 Con Conectores Tipo Europa, Usa, Nitto E Italia

CAJA  
GRANDE  
100

CAJA  
PEQUEÑA  
25



## Pistola de aire 16mm

**605664**
**TAT3031.1**

Boquilla 16 mm  
 Entrada aire 1/4"  
 Presión 2-6,3 bar  
 Caudal 100-200 L/min

CAJA  
GRANDE  
50



## Pistola De Clavo Neumática Con Gatillo De Seguridad

**605274** **TAT83301**

Con capacidad de clavos 100pcs  
 Usa clavos de tamaño 10-30mm  
 Y calibre ga18,1.25x1.00mm  
 Presión de trabajo 0.4-0.7mpa(60-100psi)  
 Con conector tipo europeo/usa/italiano



## Pistola De Clavos Neumática 15-50Mm

**216760** **TAT83501**

Conector De Tipo Usa  
 Con Uñas Brad De 1000Pcs  
 Capacidad De Carga 100Pcs  
 Con Conector De Tipo Europa  
 Tamaño Brad 15-50Mm Ga18, 1.25X1.00Mm  
 Conector Tipo Nitto Y Conector De Tipo Italia  
 Presión De Operación 0.4-0.7Mpa(60-100Psi)

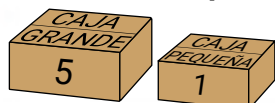

## Juego de destornilladores 4 piezas

MANUAL

**605335** **THT250604**

1Pcs SL5.5X100mm  
 1Pcs SL6.5X150mm  
 1Pcs PH1X100mm  
 1Pcs PH2X150mm  
 Material CRV Hoja redonda

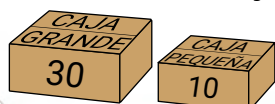

## Ventosa Doble Succión

**605679** **TSP02501**

Mango De Abs  
Soporta 50Kg De Peso  
Diámetro De Succión 115M



## Tijera De Aviacion De 250 Mm (10") Recta

**605680** **THTJ532106**

Espesor Máx  
Acero Inoxidable  $\leq 0.7$  Mm  
De Corte Acero Al Carbono  $\leq 1.2$  Mm



## Mini Martillo Forjado Acero #45 Mango Fibra Vidrio



**216781** **THTM7386D**





## Martillo Tipo Ingles Acero #45 Mango Fibra Vidrio



## Martillo Tipo Ingles Acero #45 Mango Fibra Vidrio



## Martillo De Bola Acero 45# Mango Fibra Vidrio 16Oz/450G



## Martillo De Bola Acero 45# Mango Fibra Vidrio 320nz/900G



**605554** **THT74326**



## Martillo Tipo Ingles Acero #45 Mango Fibra Vidrio



**605555** **THTCH0166**



## Mazo De Goma 45% Goma Natural 16Onz/450G



**605306** **THT731636**



## Cinta Metrica 30mt X 12.5mm Mango Ergonómico



605402

TMT11306



## Cinta Metrica De 30 Mt X 12.5mm De Fibra De Vidrio



605509

TMTF12306



## Nivel De Burbuja De 30 Cm V



605512

TMT2306



## Nivel De Burbuja De 40cm V

**605513****TMT2406**

## Nivel De Burbuja De 60cm V

**605514****TMT2606**

## Nivel De Burbuja De Superficie Plana 24.5 Cm

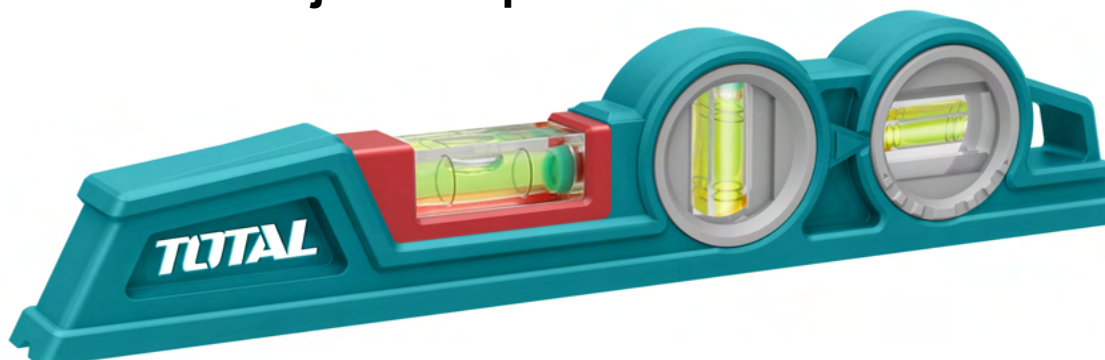
**605405****TMT221306**

## Nivel De Burbuja Magnetico De 60 Cm En Aluminio



**605515** TMT20605M



## Tester Digital 600v

**605408** TMT460012

Cuenta con pantalla LCD  
 Voltaje DC: 200mV / 2V / 20V / 200V / 600V  
 Voltaje CA: 200V / 600V  
 Corriente CC: 200uA / 2mA / 20mA / 200mA / 10A  
 Resistencia: 200/ 2k/ 20k / 200k / 2M (omnions)



## Multimetro Digital Rms

**TMT47503**

Voltaje DC: 600mV/6V/60V/600V/1000V±(0.5%+3)  
 Voltaje AC: 6V/60/600V/750V±(0.8%+3)  
 Corriente DC: 6µA/6mA/60mA/600mA±(0.8%+3), 10A±(1.2%+3)  
 Resistencia: 600Ω/6kΩ/60kΩ/600kΩ/6MΩ±(0.8%+3), 60MΩ±(1.2%+3)



## Pinza Amperimetro Digital 600v

**605410** **TMT462002**

Voltaje DC 0-600V  
 Voltaje AC 0-600V  
 AC Actual 2A/200A  
 Resistencia 2kΩ/20kΩ

000  
LED



## Pinza Amperimetro Digital Conteo 6000

**TMT46002**

Voltaje DC: 0-600V±(0.5%+3)  
 Voltaje AC: 1.0-600V±(0.8%+5)  
 AC Actual: 10mA-400A±(2.5%+5)400A-600A±(3%+5)  
 Resistencia: 0.6Ω±/(0.8%+3)

000  
LED



## Multimetro Digital Con Pinza

**605405** **TMT221306**

Voltaje DC: 60mV/600mV/6V/60V/600V/1000V  
 Voltaje AC: 60mV/600mV/6V/60V/600V/750V  
 AC Actual: 60A/600A/1000A  
 Resistencia: 600Ω/6kΩ/60kΩ/600kΩ/6MΩ/60MΩ

000  
LED

CAJA  
GRANDE  
40



## Medidor de laser rango de 0.05 -60 mts

**605517** TMT56016

Rango 0.5-60m  
 Precision  $\pm 2.0\text{mm}$   
 Tipo de laser 620-690nm,<1mW,Class 2

000  
LED

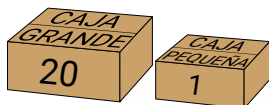

## Laser de linea autonivelante

**605518** TLL156506

Rango de trabajo: 0-15 m  
 Precisión de línea:  $\pm 1.5\text{ mm}$  a 5 m  
 Tiempo de nivelación < 4s  
 Ángulo autonivelante  $\leq 4^\circ$   
 Tipo de láser 650 nm clase 2, < 1 m W  
 Con imán  
 Con colgador  
 Con función de laser cruzado

000  
LED

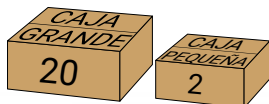

### Candado bronce de oreja 50Mm



605415

TLK32502

LATON

CAJA GRANDE  
48

CAJA PEQUEÑA  
12

### Candado bronce de oreja 60Mm



605416

TLK32602

LATON

CAJA GRANDE  
36

CAJA PEQUEÑA  
6

### Candado bronce de oreja 70Mm



605417

TLK32702

LATON

CAJA GRANDE  
24

CAJA PEQUEÑA  
7



## Candado Anti Cizalla De Bronce 60mm



**605418** **TLK32603**

LATON

CAJA GRANDE  
48

CAJA PEQUENA  
6

## Candado Anti Cizalla De Bronce 70mm



**605419** **TLK32703**

LATON

CAJA GRANDE  
36

CAJA PEQUENA  
6

## Candado Anti Cizalla De Bronce 90mm



**605420** **TLK32903**

LATON

CAJA GRANDE  
24

CAJA PEQUENA  
6

## Soporte De Soldadura Escuadra Magnetica De 5"

**216756** **TAMWH75052**

Angulo de sostener 45°, 90°, 135°

Fuerza de tracción 75 Libras

Material Metal

Materiales Imán y Acero

Peso (Kg) 1.278 Kg

Tamaño 5"

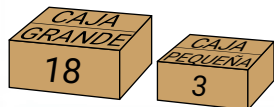

## Soporte De Soldadura Escuadra Magnetica De 4"

**470853** **TAMWH50042**

Angulo de sostener 45°, 90°, 135°

Fuerza de tracción 50 Libras

Material Metal

Materiales Imán y Acero

Peso 0.667 Kg

Tamaño 4"

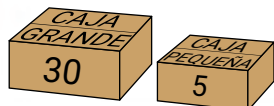

## Juego De Dados Socket De Impacto De 1/2» Dr. 10 Pz



**216758** **THISTD12101**

Largo 38 mm CrMo

Tratamiento Térmico

Tamaños 10.12.13.14.15.17.19.21.22.24 mm

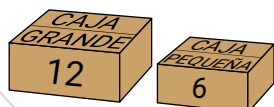

**10Pcs/Set** **1/2"** **CR-MO**

## Juego De Dados Socket Largos De Impacto De 1/2" Dr. 10 Pz

**216759** **THKISD1210L**

Material crmo  
 Longitud 78mm  
 Colgador plástico  
 Tratamiento térmico  
 10 pzas 1/2" set de dados de impacto  
 Tamaños 10.12.13.14.15.17.19.21.22.24mm

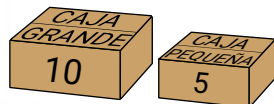

**10Pcs/Set 1/2" CR-MO**

## Juego de brocas de 16 piezas

**216761** **UTACSD3165**

Incluye :

(6) para metal: 5/64", 7/64", 5/32", 3/16", 7/32", 5/16"  
 (5) para concreto: 5/32", 3/16", 7/32", 5/16", 3/8"  
 (5) para madera: 5/32", 3/16", 15/64", 5/16", 25/64"  
 (6) para metal: 5/64", 7/64", 5/32", 3/16", 7/32", 5/16"  
 (5) para concreto: 5/32", 3/16", 7/32", 5/16", 3/8"  
 (5) para madera: 5/32", 3/16", 15/64", 5/16", 25/64"



## Juego De Brocas Para Concreto. 5 Pz

**216762** **UTACSD5051**

Tamaños 5/32 "X3-3 / 8", 3/16 "X4",  
 1/4 "X4-3 / 4", 5/16 "X4-3 / 4", 3/8 "X4-3 / 4 "



**Disco De Corte Para Metal Plano**



**216778** TAC2211802

Diámetro 7"  
Hueco 22.2mm  
Espesor 1.6mm



**Disco Para Corte Para Metal abrasivo**



**605425** TAC2212302

Diámetro 230mm  
Hueco 22.2mm  
Espesor 1,6mm

**Disco De Corte Para Metal Plano**



**605426** TAC2213551

Diámetro 335mm  
Hueco 25.4mm  
Espesor 3mm



**Disco De Diamante 115 X 22Mm Segmentado**

**605297** TAC2111153

Usos Concreto  
Para corte en seco  
Medida 115 X 22mm  
Ancho (cm) 0.75 cm



**Disco De Diamante 115Mm (4-1/2"") X 22Mm**

**216763** TAC21111532

Ancho De Navaja 7Mm  
Para Corte En Seco

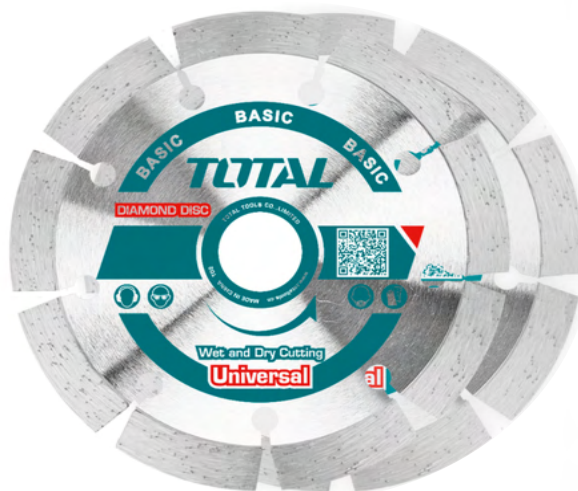

## Disco De Diamante 180 (7") X 22Mm

**605298**
**TAC2111803**

Material crmo  
 Longitud 78mm  
 Colgador plástico  
 Tratamiento térmico  
 10 pzas 1/2" set de dados de impacto  
 Tamaños 10.12.13.14.15.17.19.21.22.24mm



## Disco De Diamante 230 (9") X 22Mm

**605299**
**TAC2112303**

Para Corte En Seco  
 Para piezas de metal, piedra, acero inoxidable



## Disco De Diamante Liso 115 (4-1/2") X 22Mm

**605300**
**TAC2121153**

13000 RPM  
 Para usar con agua  
 Ancho de sierra 5mm



## Disco De Desbaste Para Concreto 4 1/2" 115 Mm

**216764** TAC2421151

Material metal  
18 hojas de desbaste  
Medida  $\varnothing$  (mm) 115 x 22.2 (7/8")



## Disco Corte Madera 185Mm(7-1/4") 60T

**605434** TAC231413

Dientes 60T  
Mandril 20mm  
Max RPM 8200  
Diámetro 185mm, 7 1/4"  
Anillo reductor(mm) 16



## Disco De Alambre 3" Con Rosca 5/8" 11 Unc

**216765** UTAC31031

Diámetro Alambre 0.3 Mm



## Juego 357 Pcs Acces P/Mototool

**216766 TACSD13571**

Incluye discos d/corte,  
lijas, cepillos, brocas,  
desvaste y gravado,  
piedras varias, ruedas d/pulido.

**357PCS**



## 10Pcs /Pack Punta Stella Ph2 50 Mm Para Tornillos



**216767 TAC16PH223**



## Juego 10Pcs Puntas Phillips Ph2 Y Paleta



**216768 TAC16HL133**



## Juego De Puntas Para Destornillado Ph2 (10 Piezas, 50Mm)

216769

TACIM16PH223

CAJA GRANDE  
100



Impact



50mm

## Juego De Puntas Magnéticas De Impacto

216771

TACIM16PH263

Tamaño PH2  
Largo 150 mm  
Vástago hexagonal 1/4 "  
(10Pzas) Puntas Magnéticas Ph2 - 150Mm

CAJA GRANDE  
50



10Pcs/set



Impact 150mm

## Juego Puntas Destornilladores Tipo Broca

216772

TACSD18306

Tamaño 25mm  
30 Pzas Ph1-2-2-2-3, SI3-4-5-6-7  
Pz1-2-2-2-3, T10-15-20-25-27-30-40, H3-4-5-6

CAJA GRANDE  
40

CAJA PEQUEÑA  
4

30Pcs/set



IMPACT



## Juego De 9 Pza Magneticas Con Adaptador

**216773** **TACSD3091**

Ph1,Ph2,Ph3,SI4.0,SI5.5,SI6.5,Pz1,Pz2

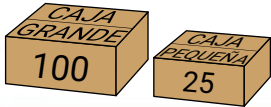

## Juego De Puntas De Destornilladores Tipo Broca

**216774** **TACSD10306**

1 adaptador magnético  
PZ0-1-2-2-3, PH0-1-2-2-3-4, SL3-4-5-6,  
T10-15-20-25-27-30-40, H3-4-5-6, S1-2-3

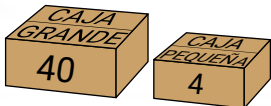

## Set De Adaptadores Para Sockets 1/4", 3/8", 1/2"

**216775** **TAC273651**

Material 50Bv30  
Shank 1/4" Hexagonal  
3Pcs/Set 1/4", 3/8", 1/2"  
Longitud li: 73Mm (1/2")  
Longitud l: 65Mm (1/4", 3/8")

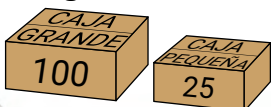

## Llave Para Mandrill Para 13 Mm Largo 10 Mm

**216776** **TAC470131**

Incluye discos d/corte,  
Lijas, cepillos, brocas,  
desvaste y gravado,  
piedras varias, ruedas d/pulido.

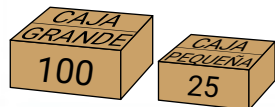

## Set 10 Hojas Cuchillo Cartonero Retractil Total 61mm

**605615** **THT519611**

Para Exacto De Metal 61X19Mm

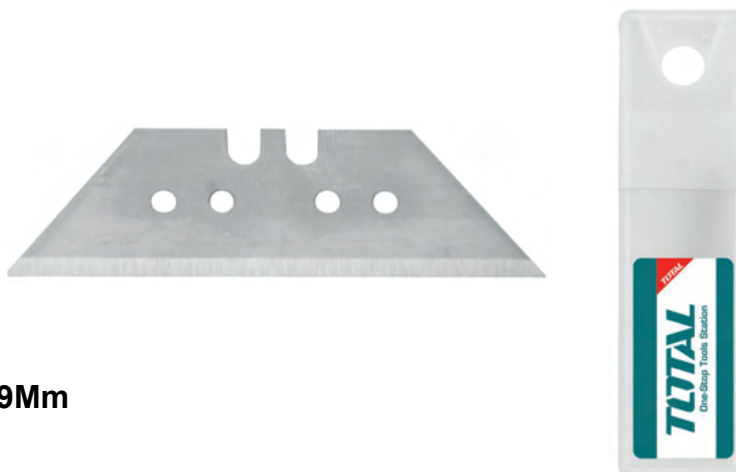

## Rueda De Corte De Repuesto Para Cortadora

**605655** **THT578004B**

Cortadora de ceramica

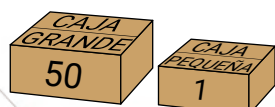

## JJuego De 6 Barras De Silicon

**605667** **TACGT2061**

Longitud 20cm  
Diámetro 11,2 mm  
Material resina de petróleo



## Juego De Brocas Para Concreto De 5 Piezas

**605663** **UTACSD5055**

Tamaños:  
5/32" X 3-3/8": 3/16" X 4"  
1/4" X 4-3/4": 5/16" X 4-3/4": 3/8" X 4-3/4"



## Kit En Lata De 50 Discos Corte De Metal Y Acero Inoxidable

**605295** **TAC22111550**

Disco Plano Tipo 41  
Cantidad x Empaque 50  
Medidas 115Mm (4-1/2"") X 1.2Mm (3/64") X 22.2Mm (7/8"")



## Hoja De Sierra De 235 mm (9-1 / 4 ") 60T

**605677** **TAC231623**

235 mm (9-1 / 4 ") 60T  
Eje: 30 mm 16 mm y anillo de 25,4

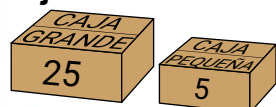

## Disco Corte Aluminio Tct 254 Mm (10") 100T

**605436** **TAC2337210**

Para Cortadora Ts42182551 Ts42182553  
Arbor 30Mm 16Mmm y anillo de 24.5 Mm

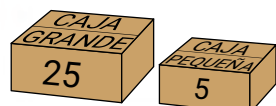

## Disco Corte Aluminio 305 Mm (12") 120T

**605437** **TAC2339212**

Corte de aluminio  
Sierra ingletadora  
Max. velocidad 5000 / min  
Rango de aplicación 120T  
Diámetro de la hoja 305 mm (12 "),  
Eje 30 mm, anillo de reducción 25,4 16 mm

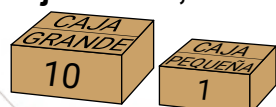

## Grapadora Industrial. Grapas 6-14Mm, Peso 800G



## Marco De Sierra Para Metales 12

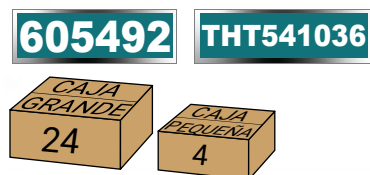
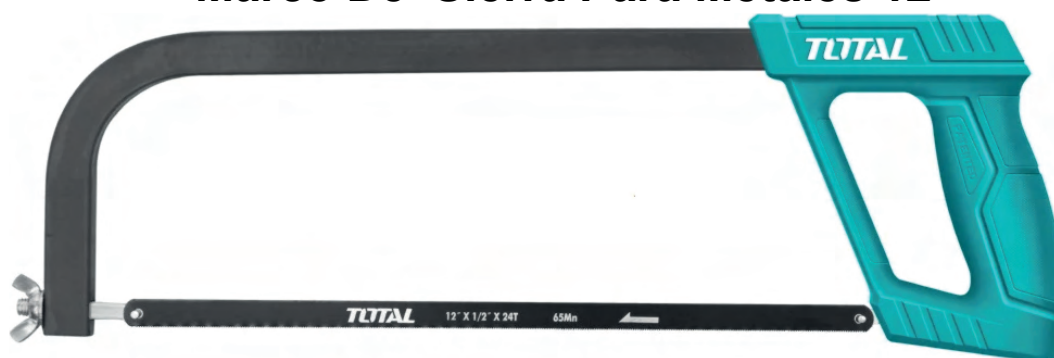

## Marco De Segueta Ajustable 300mm (12")



## Segueta 12"/300 Mm Con Mango Suave



605609

THT541026



## Segueta Industrial Para Metal De 300 Mm / 12"

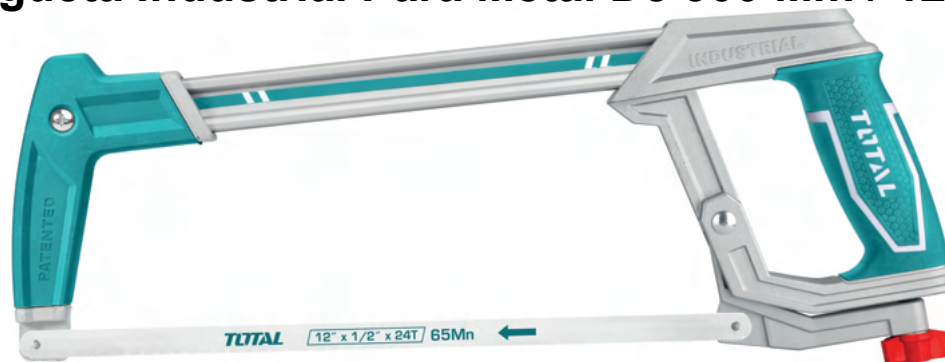

605610

THT54106



## Serrucho De Mano De 18 " / 450 Mm

# 18" (450mm)

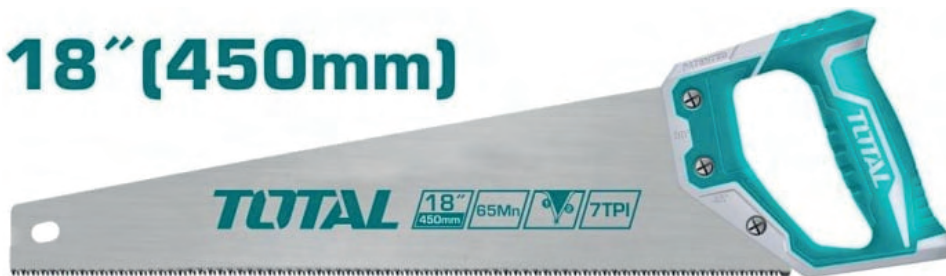

605611

THT55450



### Serrucho De Mano De 18 "/ 65 Mm



**605361** **THT55186**

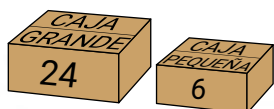

### Serrucho Trasero 12"/300 Mm

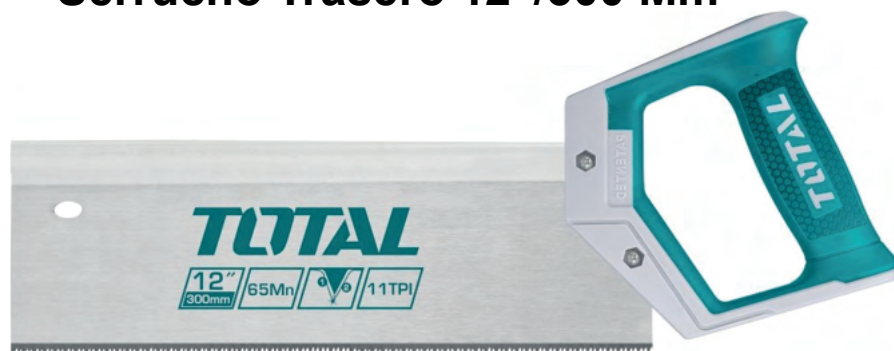

**605612** **THT59126B**

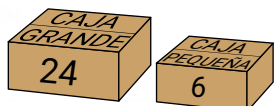

### Cutter De 173 Mm Con Cuchillas De 18 Mm X 100 Mm



**605494** **THT511826**



## Cutter Con Cuchillas De 18 Mm X 100 Mm Aleación de Aluminio



**605364** **TG5121806**

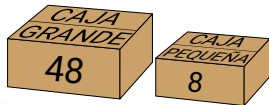

6 PZS SK5 cuchillas

## Cutter 175 Mm. Con Cuchillas De 61 Mm X 19 Mm



**605365** **TG5123101**

## Zinc Alloy

6PCS SK5 blades

## Prensa De Mesa 8» Fuerza De 2500kg



**605367** **THMFK0156**

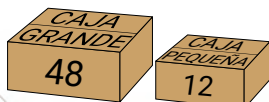



## Cuchilla Para Bisturi 10pcs X 18 Mm X 100 Mm



18mm x10PCS

325899

THT519112



## Cuchillo Para Pelar Cables



605458

THT51882



CURVED BLADE

## Decametro Cinta Fibra De Vidrio 50m



605528

TMTF12506

## Mochila Porta Herramientas 16"

# 16"



**570680**

**THT26161**

## Mochila Portas Herramienta 24"

# 24"



**605350**

**THT16241**

With **18** Pockets  
Max Load **25** kgs

## Navaja Bisturi Utilitario Con 5 Cuchillas (Triangul )



**x5** SK5 blades

**605495**

**THT5116118**

## Navaja Bistury Retractiv De Mano 18mm



**449795**

**THT511816**

## Navaja Bistury Retractiv Indust 6 Cuchilla Triangulo

**INDUSTRIAL**



**Zinc Alloy**



**6PCS SK5 blades**

**605365**

**TG5126101**

## Nivel Aluminio 2 Gotas 24"



**605510**

**TMT26036**

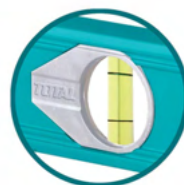

**Diseño único total**

## Cortaremache Industrial 24"



**393205**

**THT113246**



Comfortable Rubber Handle

**Cr-V**

**600mm(24")**

## Cruceta Para Autos 16" Con Estuche



**605391**

**THTRCW40231**

## Cuchilla Para Bisturi X 10 Pz Triangular



**325900**

**THT519001**

## Tijera Corta Ramas 30"

**605521****THT1527401**

## Tijera Para Prado Dos Manos 22"

**605520****THT1516301**

## Tijeras De Electricista 7"

**605457****THT117871**

## Torres De Bloqueo 3 Ton Jgo 2#

605401

THJS0301



### 3Ton

2PCS/Pair



## Espatula Industrial 80 Mm ( 3" )

605501

THT83806



## Espatula Industrial 100 Mm ( 4" )

605374

THT831006



## Serrucho Con Mango Pastico De 20" (500mm)



**605362**

**THT55206**



## Serrucho Con Mango Pastico De 22" (550mm)



**605493**

**THT55226**



## Serrucho Para Gypsum 6"/150mm



**605363**

**THWBSW66**



## Paquete 10pza De Hojas Para Cutter



605366

THT519181



## Tijeras De Hojalatería De 10» Acero De Alta Calidad



605370

THT524101



## Corta De Vidrio 178mm Cortador De Vidrio Heavy Duty

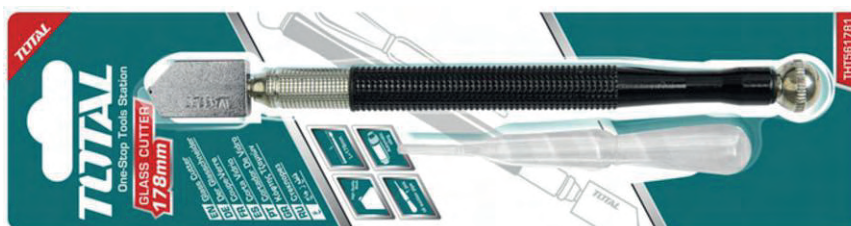

605368

THT561781





### Cutter 3/4 X 4" 169mm



**3PCS**  
SK5 blades

**605613**

**THT511836**

CAJA GRANDE  
96

CAJA PEQUEÑA  
12

### Cutter Con Cuchillas De 61 Mm X 19 Mm



**605614**

**THT5126128**

CAJA GRANDE  
72

CAJA PEQUEÑA  
12

### Cutter Plegable Con Mango De Aluminio Con Cuchillas De 61 X 19 Mm



**Stainless steel**



**x6**  
SK5 blades

**605616**

**THT5136288**

CAJA GRANDE  
72

CAJA PEQUEÑA  
8

## Herramienta Multifuncional En Acero Inoxidable



605496

TFMFT01151

CAJA GRANDE  
36

CAJA PEQUENA  
6



## Ventosa, Mango De Abs Soporta 25Kg De Peso



605617

TSP01251

CAJA GRANDE  
36

CAJA PEQUENA  
3

## Tijeras De Aviador 250Mm(10")



605619

THT521106

CAJA GRANDE  
40

CAJA PEQUENA  
5

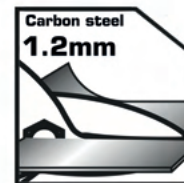
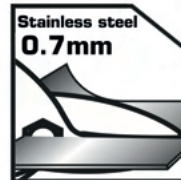

## Tijeras De Aviacion (Recta) 10 "/ 250Mm Acero



**605620** **THT522106**

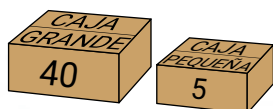

## Tijera De Aviador Derecha 250Mm(10")

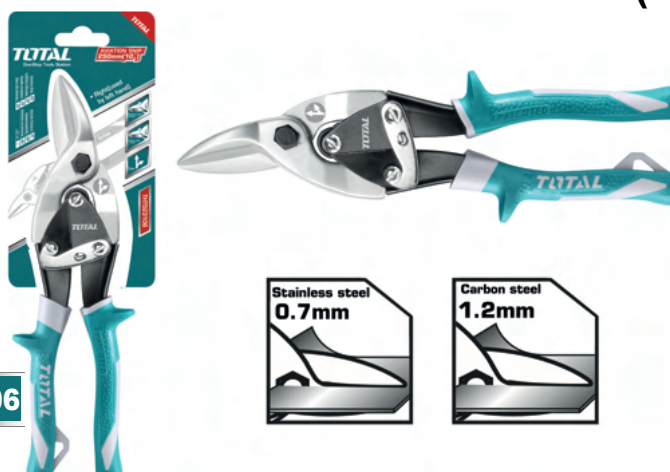

**605618** **THT523106**

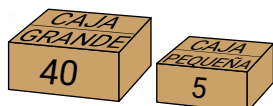

## Tijera De Aviacion Larga Recta De 300 Mm 12"



**605621** **THT525106**

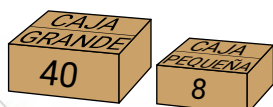

### Tijera De Aviacion De 250 Mm (10") Izquierda



**605497** **THTJ531106**

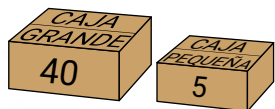

### Tijera De Aviacion De 250 Mm (10") Derecha



**605369** **THTJ533106**

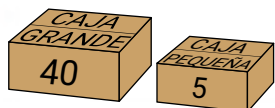

### Juego De Tijeras De Aviacion De 250 Mm 10"



**605622** **THT520106K**

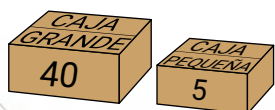

## Tijera De Hojalatería De 12" Acero Forjado



## Tijera De Hojalateria De 10"



## Tijera De Hojalateria De 12"



## Cinta Métrica (Métrico / Pulgada) Acero De 2Mts



Metric and Inch

605641

TMT126321



## Cinta Metrica Y Pulgada 3 Mts X 16 mm



605642

TMT126031



## Cinta Métrica 3 Funciones De 5Mts Botón De Parada 19mm



605643

TMT126051



### Cinta Metrica Y Pulgada 8 Mts X 25 mm



**605644** **TMT126081**

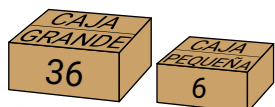

### Cinta Métrica De Acero De 5 M X 19mm



**605645** **TMT126251**

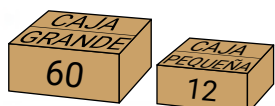

### Cinta Métrica (Métrico / Pulgada) Acero De 8 Mts



**605646** **TMT126681**



## Grata Copa Nylon 2" Esp 1/4" Para Taladro



**309991**

**TAC33025**

## Grata Copa Nylon 3" Esp 1/4" Para Taladro



**309992**

**TAC33035**

## Disco Abrasivo Desbaste 4-1/2 X 1/4"



**605427**

**TAC2231151**



## Disco Abrasivo Desbaste 7" X 1/4"

605428 TAC2231801



## Disco Abrasivo Desbaste 9" X 1/4"

605429 TAC2232301



## Disco De Diamante Turbo 4-1/2"

605430 TAC2131151HT

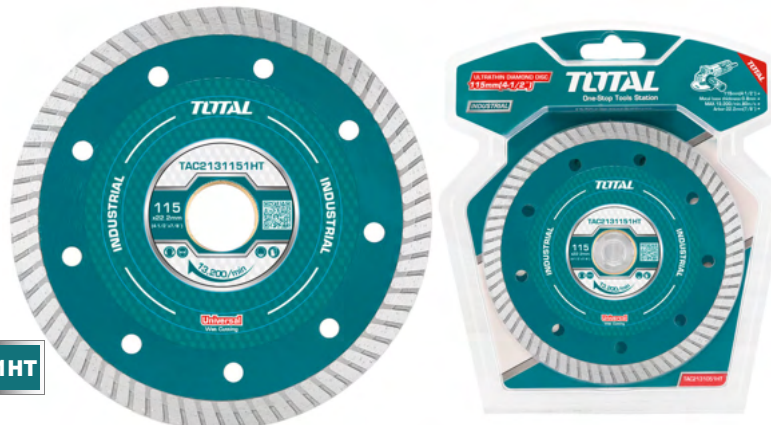

## Disco De Diamante Turbo 7



605431

TAC2131801HT

## Sierra Circular Tungst 4.1/2" X 40 Dts



605432

TAC231255

## Sierra Circular Tungst 5.1/2" X 24 Dts



605526

TAC232241

## Sierra Circular Tunast 6.1/2" X 24 Dientes



**605524** **TAC2323111**

## Sierra Circular Tungst 7.1/4" X 30 Dits X 2 Unds



**605433** **TAC231410**

## Sierra Circular Tungst P Aluminio 8.1/4" X 60 Dits



**605435** **TAC233523**

## Flexometro Profesional 3 Mtrs X 16 Mm Freno Contun



**605508**

**TMT126231**

## Grata Circular Nylon 3" Esp 1/4" Para Taladro



**309994**

**TAC34035**

## Grata Circular Nylon 4" Esp 1/4" Para Taladro



**309996**

**TAC34045**

## Barra Extension Para Sockets De 1/2" Largo 5"



**605395**

**THEB12051**



## Barra Extension Para Sockets De 1/2" Largo 10"



**605396**

**THEB12101**



## Diferencial Para 1 Tonelada

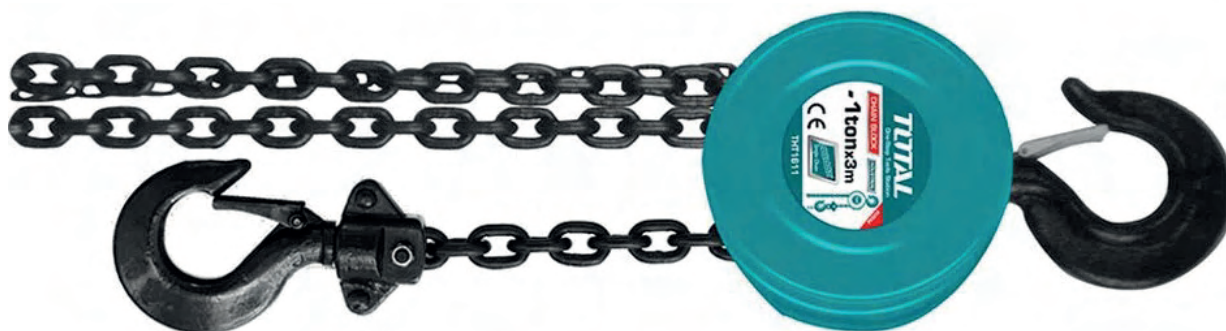

**605506**

**THT1611**



## Gato 2 Ton / Tipo Botella Con Válvula De Seguridad

605397 THT109022

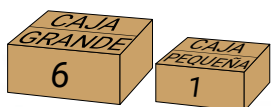

## Gato 6 Ton / Tipo Botella Con Válvula De Seguridad

605398 THT109062



## Gato 12 Ton / Tipo Botella Con Válvula De Seguridad

605399 THT109122



## Gato Hidráulico De Piso 2ton Con Patines



**605505**

**THT10821**



## Gato Hidráulico De Piso 3ton Con Patines



**605400**

**THT10832**



## Destornillador De Tensión 3mm X 140mm 100-500v



**605406**

**THT291408**



## Diferencial Para 2 Toneladas

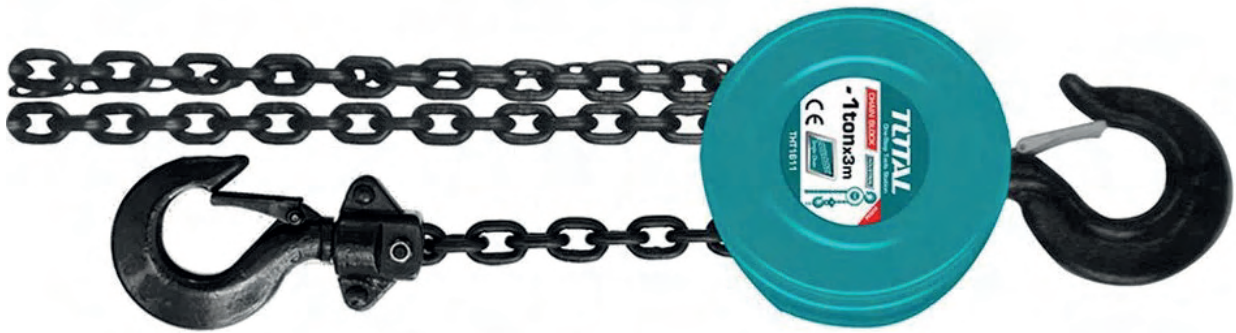

**605507** **THT1621**

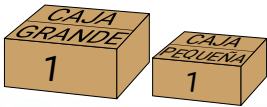

## Engrasadora Manual 400cc 14oz



**254400** **THT111051**

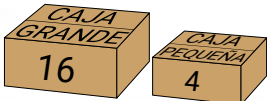

## Engrasadora Neumática 30 Litros



**605499** **THT118302**





## Gato Hidráulico Largo Estilo Patín

**605638** **THT10834**

De bajo perfil  
Con bomba doble para  
levantamiento rápido  
Capacidad 3 toneladas  
Altura mínima 85mm,  
Altura máxima 515mm



80mm  
Low Profile

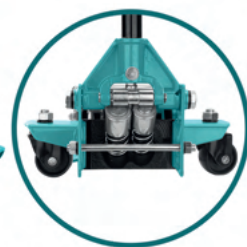

Fast lifting  
Dual pump

## Diferencial Manual 2 Toneladas Cadena 3m



**605639** **TCBK0202**



## Diferencial Manual 3 Toneladas Cadena 3m



**605640** **TCBK0203**

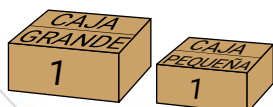

## Extension Barra Articulada Flexible De 1/2"



605635

THTFX12151



## Cortador De Azulejos 600 Mm



605636

THT576004



## Gato Hidráulico De Botella De 20 Toneladas

605637

THT109202

20 toneladas  
 Con válvula de seguridad  
 Min. Altura: 242 mm  
 Max. Altura: 452 mm



## Barra Extension Para Sockets De 1/2" Largo 5"



**605395** THEB12051

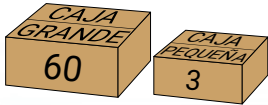

## Barra Extension Para Sockets De 1/2" Largo 10"



**605396** THEB12101

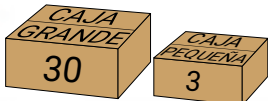

## Diferencial Para 1 Tonelada

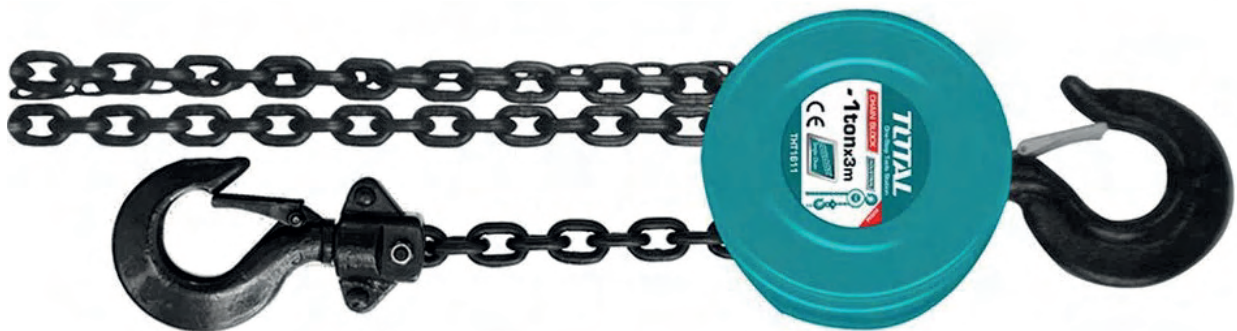

**605506** THT1611



## Diferencial Para 2 Toneladas

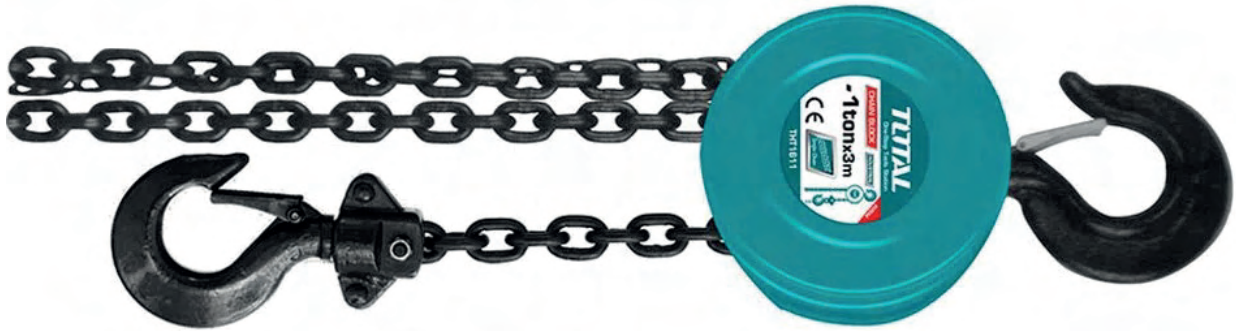

**605507** **THT1621**

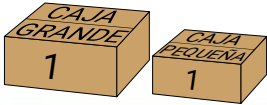

## Engrasadora Manual 400cc 14oz



**254400** **THT111051**

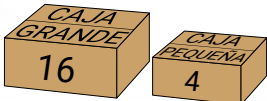

## Engrasadora Neumática 30 Litros



**605499** **THT118302**



## Gato 2 Ton / Tipo Botella Con Válvula De Seguridad

605397 THT109022

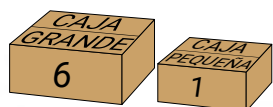

## Gato 6 Ton / Tipo Botella Con Válvula De Seguridad

605398 THT109062



## Gato 12 Ton / Tipo Botella Con Válvula De Seguridad

605399 THT109122



## Gato Hidráulico De Piso 2ton Con Patines



**605505**

**THT10821**



## Gato Hidráulico De Piso 3ton Con Patines



**605400**

**THT10832**



## Destornillador De Tensión 3mm X 140mm 100-500v



**605406**

**THT291408**



## Destornillador De Tensión 4mm X 190mm 100-500v



**605407**

**THT291908**



## Cortadora De Cerámica 80cm Espesor 14mm Corte



**605504**

**THT578004**



## Equipo De Rodillo De Pintar 230mm/9» Y Bandeja



**605379**

**THT81122301**





CAJA GRANDE  
120

CAJA PEQUEÑA  
12



### Nivel De Burbuja De 40 Cm

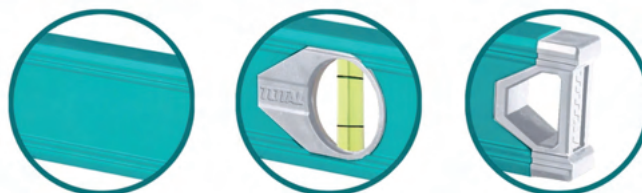

**605647**

**TMT24036**



### Nivel De Burbuja De 100 Cm

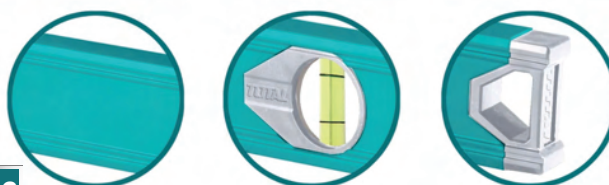

**605511**

**TMT210036**



### Escuadra Angular De Acero Inoxidable De 300 Mm (12")

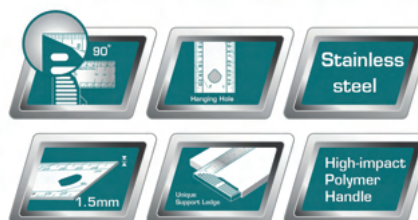

**605648**

**TMT61126**



## Regla de ángulo digital

**605649** **TMT333601**

Rango de medición: 0 - 360o 0 - 200mm / 0 - 400mm (180o)

Lectura: 0.05o 0.1mm / 0.01 "

Batería: 3V

Graduación Métrica

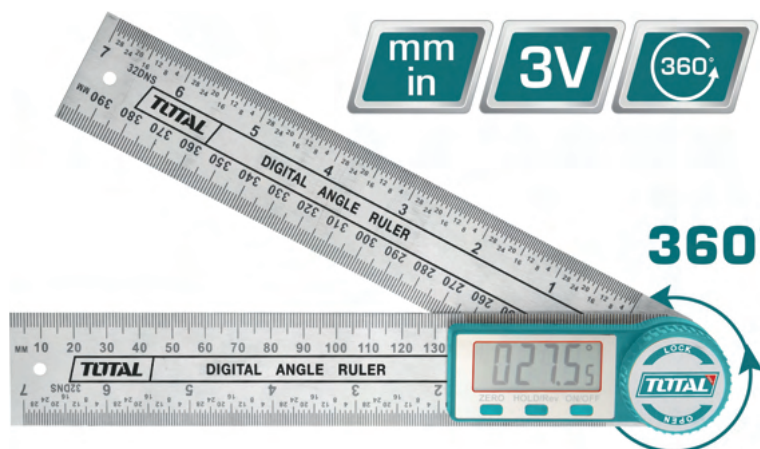
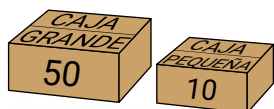

## Probador de Corriente Digital

**175713** **THT292201**

Voltaje CA: 100-500 V, CC: 12-220 V

Batería No requerido

Largo 135 mm

Ancho 23 mm

Grosor 17 mm

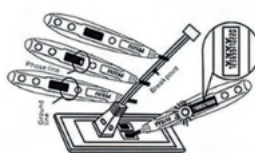
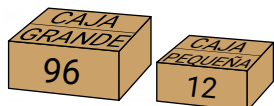

## Linterna De Cabeza Max 180 Lm

**605413** **THL013AAA2**

Duración h: 4 horas I: 10 horas

Distancia haz de 50m ipx4

Resistente a la lluvia

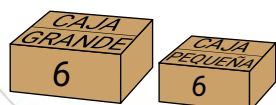

## Linterna De Mano Aleación De Aluminio Grado De Aviación 6n01-t6

**605641** **TMT126321**

Max: 400 lúmenes  
 Medio: 150 lúmenes  
 Bajos: 50 lúmenes  
 Batería de iones de litio 18650  
 Tiempo de ejecución 4h de alta luz  
 Tiempo de ejecución de baja luz 18h  
 Cuatro interruptores: resaltado, luz media, luz baja  
 Diámetro/longitud: 27,5 mm/158,3 mm



CAJA GRANDE 60  
 CAJA PEQUEÑA 20

## Serrucho Plegable 7"/ 180 Mm



**605652** **THFSW1806**

CAJA GRANDE 48  
 CAJA PEQUEÑA 6

## Candado Bronce Heavyduty 30Mm

**605653** **TLK32302**



CAJA GRANDE 144  
 CAJA PEQUEÑA 12

## Candado Bronce Heavyduty 40 Mm

**605654** **TLK32402**



CAJA GRANDE 96  
 CAJA PEQUEÑA 12

## Juego De 6 Limas Delgadas 140X3 Mm Plana



605623

THT91462



## Pistola De Silicon 9"



Suitable sealant size:



605498

THT20209



## Pistola De Calafateo De Aluminio De 9"



605372

THT20109



## Pistola De Grasa De Servicio Pesado



Dual Piston



**600cc** Rubber Handle

605624

THT111062



## Brocha De 2" 50.8Mm

**50mm**  
**(2")**



605625

THT845026



## Brocha De 3" 76.2Mm

**75mm**  
**(3")**



605626

THT845036



## Llave T.Sueca P. Tubos De Servicio Pesado De 40 °

**605329****THT172013****Ø 40mm**

## Marco Para Segueta Aislado 1000 Volt 6"

**605591****THIJH3001**

## Martillo De Caucho Blanco Mango Fibra 16oz

**605306****THT761636**

## Nivel De Burbuja Magnetico Indust 40



**605403** **TMT24056**

## Nivel De Burbuja Magnetico Indust 60



**605404** **TMT26056**

## Broca Fosner Para Bisagra 35 Mm



**216779** **TAC180351**

## Pistola Para Hidrolavadora 11316 Y 11356



605525

TGTSG026

## Pistola Para Manguera ( Jardin )



605522

THWS010301

## Ponchadora Hidraulica P.Terminales



605527

THCT024

70KN



## Ponchadora Hidraulica P.Terminales



605456

THCT070

45KN

## Gafas Monogafa Autogena



605529

TSP303

## Engrasadora Neumática 30 Litros

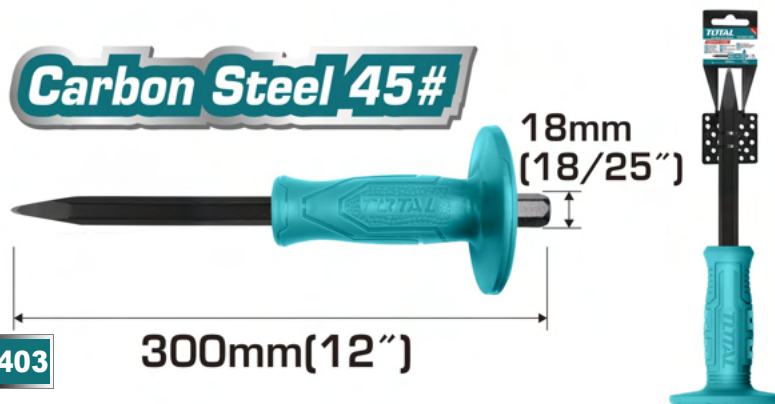

605532

TSP9403

300mm(12")

18mm  
(18/25")